

Revised Second Edition

# ***Environmental Studies***



Anil Kumar De  
Arnab Kumar De



NEW AGE INTERNATIONAL (P) LIMITED, PUBLISHERS

# ***Environmental Studies***

**This page  
intentionally left  
blank**

# ***Environmental Studies***

(For B.A., B.Sc. and B.Com. students)

Revised Second Edition

**Anil Kumar De.**

Formerly, Professor and Head of Department of Chemistry  
and Dean of Science Faculty, Visva-Bharati University  
West Bengal

**Arnab Kumar De**

Reader in Chemistry  
Raja Peary Mohan College, Uttarpara  
West Bengal



PUBLISHING FOR ONE WORLD

**NEW AGE INTERNATIONAL (P) LIMITED, PUBLISHERS**  
New Delhi • Bangalore • Chennai • Cochin • Guwahati • Hyderabad  
Jalandhar • Kolkata • Lucknow • Mumbai • Ranchi

Visit us at [www.newagepublishers.com](http://www.newagepublishers.com)

Copyright © 2005, 2001 New Age International (P) Ltd., Publishers  
Published by New Age International (P) Ltd., Publishers

---

All rights reserved.

No part of this ebook may be reproduced in any form, by photostat, microfilm, xerography, or any other means, or incorporated into any information retrieval system, electronic or mechanical, without the written permission of the publisher.  
*All inquiries should be emailed to **rights@newagepublishers.com***

**ISBN (13) : 978-81-224-2636-6**

**PUBLISHING FOR ONE WORLD**

**NEW AGE INTERNATIONAL (P) LIMITED, PUBLISHERS**

4835/24, Ansari Road, Daryaganj, New Delhi - 110002

Visit us at **[www.newagepublishers.com](http://www.newagepublishers.com)**



---

## Preface

The warm response to the First Edition of this book encouraged the authors to bring out the Second Edition in a thoroughly revised and updated form.

The Hon'ble Supreme Court of India ordered in 1991 introduction of a common course on Environment in colleges and universities at under-graduate levels but the order was not properly implemented. Displeased with non-compliance of the order, the Supreme Court again ordered in 2003 for introduction of Environment as a compulsory subject at higher secondary level in schools and under-graduate levels in colleges from 2004–2005 session and issued warning of legal action, if necessary.

The prevailing confusion in academic communities is due to lack of suitable textbooks (Green Syllabus) and also orientation about the subject among the teachers and students of various disciplines. The authors, with their long experience in environmental teaching and research, came forward to fulfil the need of the hour by meeting the challenge for the common course—the First Edition was published in 2001 and now the Second Edition is released in 2005.

The Glossary or Key Terms and Concepts is given at the end of each Chapter for the benefit of the students. Feedback Exercise (Chapter 11) followed by University Questions will

be useful for the students to test their knowledge in the subject. Chapter 8 on Environment and Public Health has been streamlined by omitting some sections. Notable additions in various sections are: Natural and Man-made Changes in Environment and Disasters (Section 1.3); Origin of the Earth–Continents and Ocean Basins, Origin of the Atmosphere (Section 2.1); Geologic Cycle (Section 2.5); Biomes–Ecosystems (Sections 3.1.1, 3.1.2) Odour Pollution (Section 6.8).

The authors cordially invite constructive suggestions and comments for further improvement of the book from fellow teachers and beloved students. It is a pleasure to place on record grateful thanks to Mr. S. Gupta, Managing Director, New Age International Publishers, New Delhi for encouragement and prompt publication. Our sincerest thanks are due to Mrs Kalpana De, Chandrima and Charchita for their constant encouragement.

Simanta Palli  
Santiniketan–731235, West Bengal  
January, 2005

**ANIL KUMAR DE**  
**ARNAB KUMAR DE**



---

# Contents

<i>Preface</i>	<i>v</i>
1. Introduction	1
1.1 Basic Concepts	1
1.1.1 Environmental Studies	2
1.2 Land Use Patterns—Agriculture, Housing and Urbanisation	3
1.3 Natural (Non-Anthropogenic) and Man-Made (Anthropogenic) Changes in Environment and Disasters	4
1.3.1 Natural Changes in Environment	4
1.3.2 Natural Disasters	5
1.3.3 Man-Made (Anthropogenic) Changes in Environment and Disasters	7
1.3.4 London Smog	8
1.3.5 Mediterranean—A Dead Sea	8
1.3.6 Nuclear Explosions	8
1.3.7 Minamata Disease	9
1.3.8 Bhopal Disaster (December 3, 1984)	9
1.3.9 Chernobyl Disaster (1986)	9
1.3.10 Gulf War Hazards	10



1.4	Development vis-a-vis Environment	11
1.5	Environmental Hazards–Human Concern about Environment	12
	<i>Key Terms and Concepts (Glossary)</i>	13
	<i>Questions</i>	15
2.	Nature and Natural Processes	16
2.1	Planet Earth–Origin and Evolution	16
2.1.1	The Sun in the Solar System	16
2.1.2	Origin of the Earth–Continents and Ocean Basins	17
2.1.3	Origin of the Atmosphere	18
2.2	Components of the Earth/Environmental Segments	19
2.2.1	Lithosphere	19
2.2.2	Hydrosphere	21
2.2.3	Atmosphere	21
2.2.4	Biosphere	22
2.3	The Climate of the Earth	22
2.3.1	Rain, Storms and Lightning	23
2.4	Origin and Evolution of Life	25
2.5	Natural/Biogeochemical Cycle	26
2.5.1	The Geologic Cycle	26
2.5.2	The Hydrological Cycle	26
2.5.3	The Oxygen Cycle	28
2.5.4	The Nitrogen Cycle	29
2.5.5	The Carbon Cycle	30
2.5.6	The Phosphate Cycle	31
2.5.7	The Sulphur Cycle	33
	<i>Key Terms and Concepts (Glossary)</i>	34
	<i>Questions</i>	36
3.	Ecosystems	37
3.1	Ecology and Ecosystem	37

3.1.1 Biomes	39
3.1.2 Ecosystems	40
3.2 Forest Ecology	42
3.2.1 Forest Conservation	43
3.2.2 Biodiversity	45
3.2.3 Sustainable Ecosystem	46
<i>Key Terms and Concepts (Glossary)</i>	47
<i>Questions</i>	48
4. Population and Environment	49
4.1 Human Population and Distribution	49
4.1.1 Distribution	50
4.1.2 Population Density	51
4.1.3 Age Structure	51
4.1.4 Doubling Time	52
4.1.5 Fertility Rate	52
4.1.6 Infant Mortality/Life Expectancy	53
4.1.7 Carrying Capacity	53
4.2 Population Stabilisation/Sustainable Development (Indian context)	54
4.2.1 Kerala Model	55
4.3 Women and Environment	56
4.3.1 Woman Power	57
4.4 Human Development	57
<i>Key Terms and Concepts (Glossary)</i>	59
<i>Questions</i>	60
5. Land and Water Resources of the Earth	62
5.1 Land, Water and Air—Interrelationship in Ecosystem	62
5.2 Land Resource and Land Uses	62
5.2.1 Land Use Planning	63
5.2.2 Watershed Management	64
5.2.3 Grazing Land	65
5.2.4 Wastelands	66

5.2.5 Mines	66
5.3 Water Resources and Water Uses	67
5.3.1 Chemical Characteristics of Water	69
5.4 Water Pollution	69
5.4.1 Water Pollutants	70
5.4.2 Ground Water Pollution/Arsenic Contamination	73
5.4.3 Case Study of Ganga Pollution	73
5.5 Waste Water Treatment	75
5.5.1 Domestic Waste Water Treatment	76
5.5.2 Drinking Water Supply	76
5.5.3 Industrial Waste Water Treatment	76
5.6 Water Quality	77
5.7 Water Pollution Control and Water Management–Water Recycling	78
5.7.1 Ganga Action Plan	79
5.7.2 Desalination	80
<i>Key Terms and Concepts (Glossary)</i>	81
<i>Questions</i>	84
6. Air Resource	86
6.1 Composition	86
6.1.1 Structure	87
6.2 Greenhouse Effect (Global Warming)	89
6.2.1 Other Greenhouse Gases	91
6.3 Ozone Hole	92
6.4 El Nino	94
6.5 Air Pollution	95
6.5.1 Primary Pollutants	95
6.5.2 Carbon Monoxide, CO	96
6.5.3 Sinks	97
6.5.4 Control of CO Pollution	97
6.5.5 Nitrogen Oxides, NO <sub>x</sub>	98
6.5.6 Hydrocarbons and Photochemical Smog	99

6.5.7 Sulphur Dioxide, SO <sub>2</sub>	100
6.5.8 Control of SO <sub>x</sub> Pollution	102
6.5.9 Acid Rain	102
6.5.10 Control of Acid Rain	104
6.5.11 Particulate	104
6.5.12 Control of Particulate Emissions	106
6.5.13 Air Pollution and Biosphere	106
6.5.14 Meteorology and Air Pollution	108
6.6 Air Quality Standards	109
6.7 Noise Pollution and Health	110
6.7.1 Sound and Human Acoustics	111
6.7.2 Noise Measurement Units	111
6.7.3 L <sub>10</sub> (18 hours) Index	112
6.7.4 Effective Perceived Noise Level (L <sub>e</sub> p <sub>n</sub> )	113
6.7.5 Noise Classification	113
6.7.6 Noise Pollution Hazards	115
6.7.7 Permissible Noise Levels	116
6.7.8 Control of Noise Pollution	117
6.8 Odour Pollution	117
6.8.1 Odourous Pollutants	118
6.8.2 Control of Odour Pollution	120
<i>Key Terms and Concepts (Glossary)</i>	120
<i>Questions</i>	123
<b>7. Energy and Environment</b>	<b>125</b>
7.1 Conventional Energy Resources	125
7.1.1 Coal	126
7.1.2 Thermal Power	126
7.1.3 Methanol, CH <sub>3</sub> OH	127
7.1.4 Petroleum or Mineral Oil	127
7.1.5 Hydroelectricity	128
7.1.6 Nuclear Power	130
7.1.7 Wood	131

7.1.8	Natural Gas	133	
7.2	Non-Conventional Energy Resources	133	
7.2.1	Solar Energy	133	
7.2.2	Biogas	136	
7.2.3	Wind Energy	137	
7.2.4	Ocean and Tidal Energy	138	
7.2.5	Geothermal Energy	139	
7.2.6	Energy Plantation	139	
	<i>Key Terms and Concepts (Glossary)</i>	140	
	<i>Questions</i>	142	
8.	Environment and Public Health		143
8.1	Pollution and Public Health Issues	143	
8.1.1	Hazardous Products	143	
8.1.2	Occupational Hazards	146	
8.1.3	Deadly Dust	146	
8.1.4	Silicosis	147	
8.1.5	Asbestosis	147	
8.1.6	Byssinosis	148	
8.1.7	Pneumoconiosis	148	
8.1.8	Child labourers	148	
8.2	Epidemiology	148	
8.2.1	Hygiene	149	
8.2.2	Health and Disease	150	
8.3	Vector-Borne Diseases and their Control	151	
8.3.1	Malaria	151	
8.3.2	Prevention of Malaria	152	
8.3.3	Treatment of Malaria	153	
8.3.4	Vector Control	153	
8.4	Water-Borne Diseases	155	
8.4.1	Cholera	155	
8.4.2	Factors for Spread of Cholera	155	
8.4.3	Control of Cholera	156	
8.4.4	Amoebiasis	157	

8.4.5	Prevention of Amoebiasis	158
8.4.6	Treatment	158
8.5	Pest Control and Management (IPM) in Agriculture	158
8.5.1	Pesticides	159
8.5.2	Toxicity of Pesticides	160
8.5.3	Integrated Pest Management (IPM)	161
8.5.4	Biological Control	162
8.5.5	Agents of Biological Control	163
8.5.6	Biotechnological Approach	163
8.6	Element (Heavy/Light Metal) Toxicity	164
8.6.1	Toxicity of Arsenic	164
8.6.2	Antidotes for Arsenic	164
8.6.3	Toxicity of Cadmium	165
8.6.4	Toxicity of Chromium	165
8.6.5	Toxicity of Lead	165
8.6.6	Toxicity of Mercury	166
8.6.7	Remedial Measures for Mercury Pollution	167
8.6.8	Toxicity of Some Organic Chemicals (Carcinogens)	167
	<i>Key Terms and Concepts (Glossary)</i>	169
	<i>Questions</i>	170
9.	Waste Treatment/Management and Recycling	172
9.1	Waste Treatment	172
9.2	Waste Classification and Disposal	172
9.2.1	Solid Waste Disposal	174
9.2.2	Detoxification of Toxic Wastes	174
9.2.3	Land and Ocean Disposal	175
9.3	Non-Hazardous Waste Management	175
9.3.1	Sanitary Landfill	176
9.3.2	Composting and Municipal Waste Composting Projects	177

9.3.3 Incineration	178
9.4 Ocean Dumping	179
9.5 Solid Waste Management by Biotechnology	179
<i>Key Terms and Concepts (Glossary)</i>	180
<i>Questions</i>	181
10. Environmental Policies	182
10.1 Environmental Instruments and Institutions	182
10.2 Environmental Policies	183
10.2.1 Forests	184
10.2.2 Biosphere Reserves	184
10.2.3 Flora and Wild Life	185
10.3 Environmental Laws/Acts	185
10.3.1 Forests	185
10.3.2 Wildlife	186
10.3.3 Water	187
10.3.4 Air	187
10.3.5 Environmental Impact assessment (EIA)	188
10.4 Environmental Movements	188
10.4.1 Chipko Movement	188
10.4.2 Silent Valley Movement	189
10.4.3 Narmada Dam	189
10.5 Environmental Ethics and Awareness	190
10.5.1 Environmental Awareness	191
10.5.2 Non-Government Organisations (NGOs)	193
<i>Key Terms and Concepts (Glossary)</i>	194
<i>Questions</i>	195
11. Feedback Exercise (Objective Test)	196
<b><i>Questions Papers</i></b>	216
<i>Calcutta University (2003)–Science Streams</i>	216
<i>Calcutta University (2003)–Arts and Commerce Streams</i>	221
<i>Calcutta University (2004)–Arts and Commerce Streams</i>	226
<i>Calcutta University (2004)–Science Streams</i>	230

**Appendices**

1. The Time Scale of Evolution	234
2. The International SI Units	235
3. Drinking Water Quality Standards	236
4. Toxic Chemicals in the Environment	238
5. The Haves and Have-nots	240
6. One Earth, One Family	241
7. India's Rank in the World	242

<i>References</i>	243
-------------------	-----

<b>Index</b>	245
--------------	-----



**This page  
intentionally left  
blank**



---

# Introduction

## 1.1 BASIC CONCEPTS

What is Environment and why do we now notice so much interest in Environmental Studies? And what do we exactly mean by Environmental Studies?

Environment is the sum total of all conditions and influences that affect the development and life of all organisms on earth. The living organisms vary from the lowest micro-organisms such as bacteria, virus, fungus, etc. to the highest, including man. Each organism has its own environment.

The word “environment” can mean many things to many people. Some consider it to be preservation of a scenic natural landscape or dwindling wildlife species. According to some, it is industrial pollution or threat to citizens’ amenities caused by the building of a road or a big factory. Others may treat it as the mother of natural resources—energy, land, water, atmosphere and minerals.

The functions of the environment in relation to man have been analysed: (1) recreation; (2) source of natural resources—agricultural, mineral and forestry which man consumes directly or indirectly; (3) “sink” for receiving wastes produced by man and his activities. The capacity of the environment to carry out these functions is damaged by human activities which

imposes four stresses on the environment: (i) “eutrophic”, i.e. the task of decomposing wastes produced by consumption and production activities; (ii) “exploitative”, i.e. cropping of plants, extraction of minerals and hunting of animals; (iii) disruptive—brought about by activities like deforestation, construction of highways and towns; and (iv) “chemical” and “industrial” stress which results from industrial development.

### 1.1.1 Environmental Studies

The earth provided the right environment—pure air, pure water, pure land, carbon dioxide which in presence of strong sunlight helped in the development of the living world consisting of plants, animals and man. Nature through its own cycles has readily helped in the evolution of life forms. These natural cycles—water cycle, oxygen cycle, nitrogen cycle, carbon cycle, etc.—are conducted in harmony with environment. In the early stage man lived in harmony with Nature but over the years this equilibrium was disrupted by man as he tried to improve his life style with the help of science and technology and as population grew beyond control which increased the need for more and more food, water and shelter. Man’s greeds and needs led to exploitation of natural resources which caused environmental degradation and world-wide crisis threatening human survival. The wave of environmental concern swept our country since the Bhopal Disaster of 1984. It is now urgently felt that the public in general and the student community in particular should be made aware of all aspects of human environment—physical, biological, socio-economic and cultural—in order to handle current environmental issues properly. The studies of all these aspects comprise Environmental Studies which is becoming important more than ever before in the new century and particularly so, for the student community.

The need for environmental awareness and education was strongly felt in the western countries in the 1960s and they

introduced environmental courses in the universities. In India it happened in the 1980s and seriously from the 1990s. In view of the growing concern about environmental degradation and threat to mankind, the Hon'ble Supreme Court of India stepped forward and in their landmark judgement in 1991 urged all the universities to introduce common course on environment for undergraduate students (B.A., B.Sc. and B.Com. streams). Accordingly the universities were under compulsion to introduce the common course from 1998 onwards to generate environmental awareness among undergraduate students. However, the academic scenario was full of confusion due to lack of motivation—dearth of suitable textbooks on the subject and of teachers with the required background for various disciplines. As a result, the students of various disciplines could not be motivated. This book has been designed to fulfil the need of the hour for Green Syllabus course by generating environmental awareness and education in simple non-technical language in order to sustain the interest of the students belonging to different backgrounds.

## 1.2 LAND USE PATTERNS—AGRICULTURE, HOUSING AND URBANISATION

Land is one of the most important components of life support systems but has been overused and rather abused. *While India has 16 per cent of world population, it has only 2.4 per cent of world area available.* That sets the upper limit of 329 million hectares (Mha) to the availability of land. Being mainly an agricultural country, land should get top priority as a matter of policy but this has been neglected. There are several demands on land—agriculture, forestry, grasslands, urban and industrial development and transport.

We get our food from crops grown on agricultural lands. But while land is limited, population growth is soaring over the years so that the gap between foodgrain production and

population growth is getting wider and wider. Only about 15 per cent of earth's surface can be farmed as the rest consists of oceans, ice caps, steep slopes and deserts. About half of this arable land is already farmed while the rest consists mainly of tropical forests and barren soil. Conversion of tropical forests into farmlands though increases agricultural production for a short period, these farmlands are eventually lost due to soil erosion, desertification. All over the world every year about 6 million hectares of farmland disappear for construction of houses, roads, mines, reservoirs, factories, etc. Such terrible loss of farmland affects our life and future as our well-being depends much on farmland. It is essential that the government pays attention to land use planning so as to slow down the loss due to urbanization, transportation and industry.

### **1.3 NATURAL (NON-ANTHROPOGENIC) AND MAN-MADE (ANTHROPOGENIC) CHANGES IN ENVIRONMENT AND DISASTERS**

#### **1.3.1 Natural Changes in Environment**

The environment is always subject to changes and these changes will continue in future. When life first appeared, there was no oxygen in the atmosphere which was full of carbon dioxide and other gases including water vapour. This primitive climate changed very slowly—it took over 2 billion years to accumulate enough oxygen in the atmosphere which helped in the evolutions of life forms (aerobic organisms). Most of the oxygen in the atmosphere to-day has come from water through the photosynthetic activities of green plants. Such change is natural (non-anthropogenic) but it altered the chemical composition of air which led to other changes in the environment. From oxygen of the atmosphere ozone was formed which slowly passed into the stratosphere where it served as a protective umbrella of ozone layer. The latter protects life on earth by absorbing the harmful ultraviolet radiation from the sun.

*Continental drifting* is an important part of natural changes. The continents were not stationary but they were slowly drifting apart. The entire outer shell of the earth is made up of huge tectonic plates<sup>1</sup> which float on the molten fluid core of the earth. Initially the continents were all joined together forming a single landmass—later on they drifted very slowly. This movement is the phenomenon of *continental drift*.

The continents have drifted for about 2500 million years and the annual rate of drifting is 20 to 75 mm. Such movement can cause splitting of part of a continent forming oceans such as the Atlantic Ocean, seas such as the Red Sea and lakes such as Lake Baikal. Collision of one tectonic plate with another can cause earthquakes, volcanic explosions and formation of mountains. Collision of Indian plate with Asian plate gave rise to the world's highest mountain, our Himalayas some 50 million years ago.

The earth's environment also passed through drastic changes in average temperature of the earth's surface creating the Ice Ages. During the earth's history the temperature fluctuated between relatively stable states about 30 times due to earth's rotation on its axis and changes in the sun's activity. The last Ice Age was about 18,000 years ago when a vast sheet of ice advanced from the North Pole covering Canada, Greenland and up to U.K. including the North Sea. As the ice moved back, vast quantities of cold water flooded the Atlantic disturbing the ocean currents. The Ice Age was over by 3000 BC and normal temperature slowly restored.

### 1.3.2 Natural Disasters

The environment has undergone sweeping changes by natural disasters viz. cyclone, typhoon, hurricane, tornado, earthquake,

---

<sup>1</sup> *Tectonic plates*: Continental land mass is a large segment of the earth's crust. It is like a huge plate which moves slowly and carries the continents along. The plates are called tectonic plates and the processes, tectonic processes which lead to earthquakes, volcanic explosions, formation of oceans and mountains.

volcanic eruptions etc. The latter have caused enormous damages on lives and properties.

Cyclone, typhoon and hurricane are the same weather phenomenon occurring in different regions of the world. Cyclones are storms that originate in the Indian Ocean and bring about extensive flood and damage in the Indian sub-continent including Sri Lanka and Mynamar. Typhoons are storms in the Pacific Ocean which cause havoc in South-East Asia while those in the North Atlantic Ocean that destroy South East USA are hurricanes. Hurricanes arise from tropical seas when the latter are warmed by the solar heat. They are powered by the heat released when the rising water vapour condenses. Most of the hurricane's energy is used to lift the air mass at the centre of the storm. Hurricanes, typhoons are in the form of spiralling air column which can have a speed of over 250 km/hr., uprooting big trees, tearing off house roofs, lifting people, cattle, cars and sucking almost anything on their path. They can whip up high waves on the surface of seas, oceans as sea level is raised as high as 8 m or 25 ft. This can cause flash floods along the coastal region. They are also accompanied by torrential rains in the region.

The earthquakes have a rather high frequency, about 100 earthquakes/hr all over the world. But most of them are of low magnitudes. The earthquake-prone zones in the world encircle the Pacific ocean (Zone 1) and on the other side, stretch from Spain, Turkey, Northern Mediterranean to Japan, Himalayas and Indonesia (Zone 2). These two zones meet near New Guinea (North of Australia). The earth's outer crust is divided into seven large tectonic plates and in between them there are more than 20 smaller plates. The plates move slowly over a partially molten mass of metals and minerals—they often converge, collide and sometimes one plate slips below another plate releasing tremendous energy in the form of seismic waves that shake the ground violently. This causes earthquake.

The intensity of an earthquake is measured on Richter scale (1 Richter is the minimum intensity detectable on the

instrument, Seismograph). The earthquake at Bhuj, Gujarat (2000 AD) measured 6.0 on the Richter scale. It destroyed the entire city of Bhuj and killed most of its population—its destructive force was equivalent to more than 100 Hiroshima-type atomic bombs.

Volcanoes sometimes erupt with devastating power, throwing molten lava, silicate dust and sulphuric acid into the atmosphere. When Mt. Pinatubo in the Philippines erupted in 1991, it increased the dust content of the atmosphere to more than 50 times its normal level. As a result, Indonesia, Malaysia missed summer in 1991.

### **1.3.3 Man-Made (Anthropogenic) Changes in Environment and Disasters**

Primitive man looked at Nature with wonder and awe because of its terrible forces as manifested from time to time as lightning, thunder, cyclone, volcanic eruption, flash flood, landslides, etc.

In his constant efforts for better living standards, man developed science and technology over the years. The Industrial Revolution of 1780 was a landmark in the history of human civilization. It started with the invention of steam engine (James Watt) in England. By 1840 England was transformed from an agricultural country into a predominantly industrial one. Textile, mining, transport and ship-building industries were developed. Manchester, Newcastle, Birmingham and Glasgow became major industrial cities of Britain. The Industrial Revolution along with colonial rule made Britain the most prosperous country in the world in the 19th century.

With development of science and technology, man continued to plunder natural resources and pollute the environment. He destroyed forests, degraded lands, threw toxic wastes into rivers and seas and also harmful gases into the atmosphere. The continuous load of pollutants into the environment brought about changes in it which ultimately



backfired into series of disasters from time to time. Several man-made disasters may be mentioned below. All these killed people and made generations to suffer from genetic and other disorders.

#### **1.3.4 London Smog**

Heavy smog (smoke + fog) conditions due to high sulphur dioxide (1.3 parts per million) content prevailed in London (December 5-9, 1952) and killed about 4,000 people in one week. The causes of death, particularly among the aged people, were bronchitis, pneumonia, etc. Similar but less severe smog recurred in 1962 when 700 people died.

#### **1.3.5 Mediterranean—A Dead Sea**

The Mediterranean sea has a coastline of 48,000 km. where about 100 million people live. It is surrounded on all sides by Europe with a Gibraltar strait connecting to the Atlantic. Here the famous luxury tourist hotels and numerous industries are located. The industries dump their wastes into the Mediterranean sea which also receives sewage from the European countries. As a result, the sea is heavily polluted with high levels of lead, chromium, mercury, etc. The seashore emits offensive odour due to pollution which forces closure of the tourist hotels for some six months every year. The sea became so heavily polluted since 1950 that it was declared a dead sea, unable to support any aquatic life (fish, plants, etc.).

#### **1.3.6 Nuclear Explosions**

The two atom bombs were dropped by USA during World War II (August 6, 9, 1945) on Hiroshima and Nagasaki in Japan. These instantly killed about 6 lakhs people, destroyed the two cities and unleashed radioactive fallout which has caused generations to suffer from various diseases including genetic disorder. Radioactive radiation continues to damage plants, soil and biosphere in the region.

### **1.3.7 Minamata Disease**

At Minamata Bay in Japan (1953–60) about 100 people lost their lives and thousands were paralysed after eating mercury-contaminated fish from the Bay. A chemical company, (Minamata Chemical Company) discharged their wastes containing mercury into the Bay where sea fish picked up mercury and concentrated it in their body as the methyl derivative. The latter was highly toxic and caused deaths of the Japanese who consumed such fish. This case of mercury-poisoning is known as the Minamata Disease.

### **1.3.8 Bhopal Disaster (December 3, 1984)**

This is the worst environmental disaster in human history. A pesticide factory, Union Carbide Corporation, leaked large volumes of methyl isocyanate (raw material for production of the pesticide, Carbaryl) into the atmosphere of Bhopal on December 3, 1984 at around midnight. Very soon the city was transformed into a gas chamber. Within a week 10,000 people died, 1000 people turned blind and lakhs of people continue to suffer from various diseases. This was mass murder in recent history and the victims/survivors are yet to receive their compensation from the Union Carbide Corporation or the government. It was the end result of negligence on the parts of the Central and State governments and factory management on one hand and lack of awareness among the public and hospital doctors on the other hand.

### **1.3.9 Chernobyl Disaster (1986)**

The worst nuclear reactor accident occurred at Chernobyl, USSR (now CIS) on 28th April, 1986. The reactor exploded as a result of uncontrolled nuclear reactions—radioactive fuel and debris shot up into air like a volcanic explosion and spread out in the surrounding areas. The accident killed at least 2000 people and damaged soil, water and vegetation in an area of

60 sq. km. around Chernobyl. Several generations in the region suffer from radiation-induced diseases including cancer.

### 1.3.10 Gulf War Hazards

The Gulf War was of six weeks duration (1991) fought between Iraq and USA-led multi-national coalition forces under the banner of the United Nations. The issue was annexation of a neighbouring state, Kuwait by Iraq in utter violation of international law and order. The war was fought for liberation of Kuwait and provides the latest example of how war destroyed the environment for several years.

The Gulf War destroyed Iraq and Kuwait. Cities and roads can be rebuilt but environment cannot be rebuilt. It will take several decades for the environment to be recovered.

About one lakh one-ton bombs were dropped on Iraq raising clouds of dust and black smoke. About 700 oil wells were set ablaze in Kuwait for over 10 months whereby black smoke and soot were shot up at high altitudes of the atmosphere. They moved with winds encircling the earth, warmed up the upper atmosphere causing temperature inversion (warm air over cool air mass). They disrupted monsoon circulation in the region and caused acid rain and crop damage in South-East Asia. The global temperature dropped by about 0.5° C. Besides these, a total of 200 million gallons of oil were dumped into the Persian Gulf which destroyed the marine ecosystem.

At the end of the war, the world witnessed a scene of “hell on Earth”—chaos of oil fire, smoke, oil spill and a landscape of mines. It was the toughest challenge to handle such environmental disaster. But this almost impossible task was handled by a number United Nations Agencies and several national and international agencies with the co-ordination of UNEP (United Nations Environment Programme) working hard for about one year.

*Gulf War II:* USA and Britain attacked Iraq again in 2003 and the war was of three weeks' duration (March–April). As before, several thousand Iraqis were killed while there was widespread devastation of environment.

#### 1.4 DEVELOPMENT vis-a-vis ENVIRONMENT

It is known that India is a rich country but with poor people; its abundant natural resources are not being properly utilised. It has the largest number of mal-nourished and illiterate people in the world (about 450 million people). According to the Indian economist Nobel Laureate Amartya Sen and Pakistani economist, Mahbub-ul-Haq, in developing countries development goals should be elimination of malnutrition, illiteracy, disease and poverty. These should be concerned not with how much is produced but what is produced and how much it is distributed. Thus development should not be treated as merely an economic goal but as a multi-dimensional concept covering economic as well as political, social and cultural aspects of life.

At the Stockholm conference in 1972 (United Nations Conference on Human Environment) the then Indian Prime Minister, Mrs. Indira Gandhi stated that “poverty is the worst form of pollution—the inherent conflict is not between environment and development but between environment and reckless exploitation of earth’s resources by man in the name of development.” The Chinese delegation also expressed in a similar tone: “Of all things in the world, people are the most precious.”

The developed countries have only 16 per cent of world population but they consume 60 per cent of world’s food, 70 per cent of global energy resources and 80 per cent of industrial wood. They are responsible for most of the present environmental degradation. And they believe that poverty and population explosion in the developing countries are the causes

for pollution. However, both the Stockholm Conference (1972) and Rio de Janeiro Conference (1992) agreed that the earth's resources must be protected for the present and future generations while economic and social development should be balanced to improve the quality of life. However USA is the lone exception as it refused to sign Kyoto protocol and reduce CO<sub>2</sub> emission.

### 1.5 ENVIRONMENTAL HAZARDS—HUMAN CONCERN ABOUT ENVIRONMENT

Industrialization is essential for economic development of our country but at the same time it creates a high-risk environment for people. Industrial emissions and wastes as well as vehicular exhausts cause health hazards. Hundreds of people including industry workers become victims of various diseases every day. Bhopal Disaster (1984) is the worst industrial disaster on record killing 10,000 people in one week (*see* Sec. 1.3).

Some 60,000–70,000 chemicals are commonly used all over the world in various industries. Apart from their benefit to industrial growth, living standards and health, many of them are potentially toxic (i.e. injurious to health). There are toxic chemicals in water and soil. India uses about 1 lakh tons of pesticides every year. It has been found that 50 per cent of our food is contaminated with pesticide residue and causes health hazards.

Since the beginning of industrial revolution (1780) the quality of the environment has steadily suffered as a result of human activities. We breathe polluted air, drink polluted water and eat polluted food in our daily lives. The situation is getting worse day by day with population explosion whereby the earth's carrying capacity is being pushed to the limit.

As a result of deforestation, many important plant and animal species have disappeared from earth. Within next 30 years about 25 per cent of the earth's species is likely to risk

extinction. This will mean loss of valuable medicinal plants, important sources of our medicines.

For the sake of his own survival on earth, man is now concerned about the environment. The need of the hour is environmental education and awareness for all so that they learn how to handle environmental issues, how to lead a better life with less pollution and make this earth a better place to live in for the present and future generations.

Environmental studies have reached the status of multi-disciplinary subject—the meeting ground of all disciplines including Arts, Science, Commerce, Medical Science, Engineering, etc. The survival of mankind is of immense concern in this 21st century and protection of our environment is of vital importance. That is why environmental education and awareness are essential among the student community so that the latter can spread the message among the common people.

### **Key Terms and Concepts (Glossary)**

*Bhopal Disaster* (1984): Gas (methyl isocyanate) leakage from a pesticide factory (Union Carbide Corporation) on December 3, 1984 at Bhopal (Madhya Pradesh) killed 10,000 people and injured lakhs of people, who are suffering even to-day. This is the worst industrial disaster in history.

*Common Course*: Meant for providing environmental education and awareness concept for the undergraduate students of all streams (Arts, Science, Commerce, etc.). The students, in turn, will generate environmental awareness among the common people.

*Continental Drift*: The outer mantle of the earth consisting of huge tectonic plates floats on molten mantle (fluid) core of the earth and moves very slowly. This movement of landmass is known as continental drift.

*Environment:* Means something that environs i.e. encircles all our surroundings—the natural world in which we live, the living and non-living objects around us in our day-to-day living.

*Environmental Studies:* The studies of the quality of environment and all aspects of human environment (physical, biological, social, economic, and cultural environment), their degradation, current issues, etc. comprise environmental studies.

*Gulf War Hazards:* The Gulf War I broke out in 1991 between Iraq and US-led coalition forces and lasted for six weeks. Thousands of Iraqis died and most of the country was destroyed while the environment was damaged due to burning oil wells.

The Gulf War II occurred in 2003 between Iraq and US-led coalition and was of 3 weeks duration. Again there was large scale death and destruction of environment.

*Chernobyl Disaster:* Nuclear reactor accident at Chernobyl, CIS (former USSR) in 1986 which killed more than 2000 people and damaged the environment due to radiation.

*Land Use:* Land is one of the most important components of our life-support system for agriculture, housing, etc. It has been overused and abused by man. Land use requires careful planning for its protection.

*London Smog:* Heavy smog (smoke + fog) conditions in London air in 1952 caused about 4000 deaths due to high sulphur dioxide pollution.

*Minamata Disease:* Caused by mercury poisoning after eating contaminated fish from Minamata Bay (Japan) in 1953–60. More than 100 Japanese died.

*Nuclear Explosions:* Atom bomb explosions due to splitting of uranium or plutonium atom by neutrons (nuclear fission) which cause large scale deaths and destruction (Cases of Hiroshima and Nagasaki, Japan in 1945).

*Urbanisation:* Transformation of land for construction of cities along with its infra-structure leads to urbanisation.

## QUESTIONS

1. What do you mean by (a) Environment and (b) Environmental Studies?
2. Give a brief account of land-use patterns.
3. Why is land-use planning important for our national policy?
4. Mention some man-made disasters.
5. Comment on human concern about environment.





---

# Nature and Natural Processes

## 2.1 PLANET EARTH—ORIGIN AND EVOLUTION

According to cosmologists, the dawn of the universe started with a *Big Bang* some 6.5 billion (1 billion = 1000 million = 100 crores) years ago. The entire matter of the universe was condensed into a cloud of gas and dust, which after consecutive expansion and contraction exploded into the *Big Bang*. The stellar body burst into pieces and each fragment was hurled into space at tremendous speed. One such fragment gave rise to our solar system. Our solar system is a tiny part of the universe consisting of numerous stars, galaxies and solar systems. The earth is also a tiny part of our solar system.

### 2.1.1 The Sun in the Solar System

The stars are visible at night while the Sun is visible during daytime. The Sun is the closest star to the Earth, about 150 million km. away. The light from the Sun takes 8 minutes to reach the Earth's surface while the light from the nearest star takes more than 4 light years. (1 light year = distance traveled by light in one year). The light and heat from the Sun are the sources of energy for the Earth.

The Sun is a big nuclear fusion reactor where nuclear fusion reactions are always occurring at the core. Four hydrogen atoms get fused at high temperature to form helium atom. The loss in mass resulting from such reaction releases tremendous amount of energy with rise in temperature. Thus solar power operates on hydrogen fuel which will last for 10-billion years providing a steady flow of heat and light and sustain life on Earth.

### **2.1.2 Origin of the Earth—Continents and Ocean Basins**

The earlier view that the Earth and other planets owe their origin to the Sun is no longer acceptable. It is now held that the primordial (original) dust cloud after Big Bang burst forth into numerous fragments and one fragment coagulated into our Solar System—Sun and other Planets—Mercury, Venus, Earth, Mars, Jupiter, Saturn, Uranus, Neptune and Pluto. The Planets rotate in elliptical orbits around the Sun at the centre—their motion is governed by the Sun's gravitational force and by their own momentum. The balance between these forces helps to keep the planets in their orbits. In our Solar System only the Earth provides optimum atmosphere and environment for sustaining life. There are many Solar Systems in the Universe.

The so-called Terrestrial Planets—Mercury, Venus, Earth and Mars probably lost their gases at the time of their creation. This is evident from the study of transformation and composition of Earth's atmosphere. Neon is rare in Earth's atmosphere but it is abundant in the stars. At the time of formation, neon might escape from the atmosphere along with water and volatile matter present in the atmosphere. The present atmosphere has been created much later when nitrogen, carbon and water escaped from the interior of the Earth. Hydrogen and helium could also have escaped to space in the earliest period as these exist only in traces in the outer region of Earth's atmosphere.

It took about a billion years for the Earth to cool from fiery ball state and gradually form solid crust on the surface. Silicate is the most common compound forming the Earth's crust to-day. High temperature reduced iron oxide to iron in presence of hydrogen in the early period. The molten iron, being heavier, sank through the silicate layer and accumulated in large pools at the Earth's core. We find today the Earth's core containing mainly rust like (ferrogenous) materials.

The Earth's surface today broadly consists of two parts—landmass i.e. continents and ocean basins. They are composed of different materials—continents made of granitic rocks (aluminium silicate) and ocean basins, basaltic rock (magnesium silicate).

### 2.1.3 Origin of the Atmosphere

Since the creation of the Earth the atmosphere underwent many changes in different geological ages. It became more or less stable since 580 million years ago (Cambrian period). Geological changes shaped the present lithosphere and hydrosphere.

At the beginning the atmosphere probably had water vapour (60–70%), carbon dioxide (10–15%) and nitrogen (8–10%) but no oxygen. As the Earth cooled down from its very hot state, there was massive condensation of water vapour which resulted in incessant rainfall for thousands of years. The rainwater filled in the cavities of Earth's surface forming seas, oceans and lakes.

Life forms first appeared in the seas some 3.5 billion years ago as blue–green algae. The evolution of plant life on Earth transformed the atmosphere. Plants assimilated carbon dioxide from the atmosphere for photosynthesis and in the process released oxygen into the atmosphere. The present atmosphere consists of nitrogen (78.08%), oxygen (20.95%), argon (0.93%) and carbon dioxide (0.33%).

The process of evolution went on—the living world appeared in the sequence: plants, animals and man. Some 5 million years ago man appeared last of all only when the atmosphere built enough stock of oxygen and the optimum environment for life forms prevailed.

## 2.2 COMPONENTS OF THE EARTH/ ENVIRONMENTAL SEGMENTS

### 2.2.1 Lithosphere

The earth's crust, made of the mantle of rocks, is the lithosphere. It includes the soil which covers the rock's crust in many places. Rocks are subjected to continuous weathering forces—rain, wind, chemical and biological. The resulting primitive soil is suitable for the growth of plants—after death and decay, plant debris returns to soil. The mineral component of soil comes from the parent rocks by weathering processes while the organic component is due to plant biomass as well as populations of bacteria, fungi and insects (earthworms). A typical soil, suitable for agriculture, contains about 5 per cent organic matter and 95 per cent inorganic matter.

Soil has an important role as it produces food for us and animals. Good soil and good climate for agriculture are valuable assets for a nation. Soil is an important component of natural cycles (*see* subsequent section of this Chapter). But due to human activities soil becomes the dumping ground for many pollutants including pesticides, fertilizers, industrial effluents and particulate matter from smoke chimneys of factories, etc.

In general, soil has a loose structure consisting of solid mineral and organic matter, air spaces. It shows broadly three zones as its depth increases. The top layer, upto several inches thick, is known as the top soil which is an index of the soil quality. This is the layer of maximum biological productivity and it contains bulk of the organic matter. Hence it is very important for vegetation cover and agricultural crops. Reckless

deforestation causes loss of top soil which also means loss of agricultural production. The underlying layer is the sub-soil which receives organic matter, salts and clay particles leached from the top soil. The third layer (zone) consists of weathered parent rocks from which the soil was formed. Plants draw water and nutrients from soil—they transport water into the plant body (roots and leaves) and then excess water into the atmosphere through leaves by the process of transpiration.

Soils have an important function, i.e. exchange of cations whereby essential trace metals are made available to plants as nutrients.

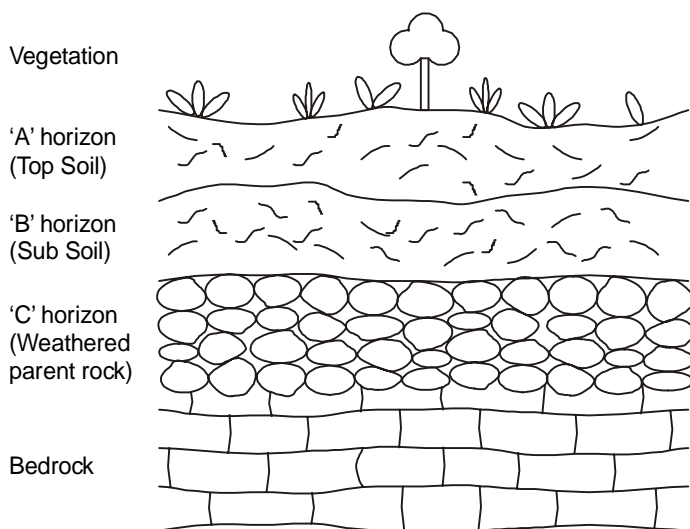

**Fig. 2.1** Soil profile showing soil horizons

Soil, however, receives large quantities of waste products—domestic, human, animal and industrial. Fertilizers and pesticides applied to crops are retained by the soil and spread into the environment, namely, water bodies by leaching. Pesticide residues in crops and food get into the human food chain causing long-time health hazards. Thus it may be

concluded that soil has direct effect on public health and well-being of a nation.

### 2.2.2 Hydrosphere

The hydrosphere consists of all types of water resources—oceans, seas, rivers, lakes, streams, reservoirs, glaciers, polar ice caps and ground water (i.e. water below the earth's surface). The history of ancient civilizations—their growth and decline—is closely linked with the quantum of water supply. Several cities and civilizations disappeared from earth due to water scarcity. The major uses of water are for irrigation (30 per cent) and thermal power plants (50 per cent) while other uses are domestic (7 per cent) and industrial consumption (12 per cent).

Surface water gets polluted by domestic sewage, industrial waste and agricultural run-off including pesticides and fertilizers. Water-borne diseases from sewage alone kill millions of people in developing countries.

### 2.2.3 Atmosphere

The major components of the atmosphere are nitrogen and oxygen while the minor components are argon, carbon dioxide and some trace gases.

The atmosphere plays an important role in maintaining the heat balance of the earth through absorption of infra-red radiation emitted by the sun and re-emitted from the earth. It protects life on earth and saves it from the hostile environment of outer space. It absorbs bulk of the cosmic rays from outer space and major portion of electromagnetic radiation from the sun. It filters out the harmful ultraviolet radiation below 300 nanometers (1 nm or nanometer =  $10^{-9}$  meter) and thereby protects the living species on earth.

Man has polluted the atmosphere by dumping harmful waste aerosols, gases and fumes into it. This has affected the world climate and the future of mankind.

### 2.2.4 Biosphere

Broadly speaking, the biosphere consists of the earth's crust, hydrosphere, atmosphere and various living species (micro-organisms to man) which exist in the zone 600 meters above earth's surface and 10,000 meters below sea level. Both biosphere and environment have close interactions with each other. Thus oxygen and carbon dioxide levels of the atmosphere depend entirely on the plant world. Green plants alone are responsible for the accumulations of oxygen in the atmosphere through photosynthesis and decay. In the early stages atmosphere was devoid of oxygen and there was no life form on earth. In general, the biological world is closely related with energy flows in the environment and water chemistry.

## 2.3 THE CLIMATE OF THE EARTH

The earth is a complex system in which the oceans, atmosphere and living species (biosphere) interact with one another and this has ultimately protected life on earth for about 3 billion years.

The earth has a unique mechanism for stabilising and controlling the global climate:

- (i) The plants and animals balance carbon dioxide level of the atmosphere which in turn acts as a global thermostat rewriting earth's temperature within optimum limits.
- (ii) The ocean plankton (plant and animal species) plays important role in regulating global climate.
- (iii) Sudden shifts in ocean current, e.g. gulf stream can initiate mini ice ages which last for centuries.
- (iv) Tiny changes in the earth's orbit, favoured by changes in the proportions of atmospheric gases, control the advance and retreat of glaciers.

The mechanism with which carbon is handled helps in the stability of the earth's climate. Carbon, the backbone of biological chemistry, is the component of rock and in the form of carbon dioxide, keeps the earth warm. With rise in carbon dioxide level in the atmosphere, say by a volcanic explosion or burning of fossil fuel, there is a corresponding increase of uptake of carbon dioxide by green plants from air and also by the oceans where it is turned into rock at the ocean floor. Similarly, if there is decrease of carbon dioxide in the atmosphere, there is less evaporation of sea water and less rainfall and carbon in the ocean rock in the floor burns through volcanoes and makes up the carbon dioxide deficiency in the atmosphere.

The earth swings back and forth between hot and cold periods with rise and fall of carbon dioxide level in the atmosphere. Thus during the dinosaur era some 100 million years ago carbon dioxide content was 4–5 times higher than to-day's and the earth was warmer by about 5° C. But during the Ice Age about 18000 years ago carbon dioxide dropped to 60 per cent of its present level and the dinosaurs were extinct for lack of vegetation, i.e. their food.

The oceans provide another mechanism for governing climate. Covering 70 per cent of the planet, oceans act as a huge fly wheel in the earth's machinery. As a huge reservoir of carbon (fixed as  $\text{HCO}_3$  mineral deposit on the ocean floor), the oceans regulate the carbon dioxide level and hence global climate. Ocean currents also play major role in setting long-term climate patterns.

### 2.3.1 Rain, Storms and Lightning

Water vapour rises in the atmosphere and is carried by winds to high altitudes where it is visible as cloud. Huge quantities of water vapour (billions of tons) are circulated by air masses, which help to maintain temperature balance that sustains life on earth. In the cold upper strata of lofty clouds water vapour



freezes on tiny floating crystals of ice which continue to grow till they are heavy enough to fall. On reaching warmer levels they melt and descend as rain. Dust or salt particles in air serve as nuclei for water vapour to condense to form cloud droplets.

Atmospheric disturbances such as thunderstorms, tornadoes, cyclones, etc. have already been described under Section 1.3.2 in the previous chapter. Here a little more detail will be given in respect of the origin of rain, storms and lightning.

In low pressure zones of air, warm and cool air meet which gives rise to storms. Warm air goes up while cooler air comes in, setting a swirling motion. Thick clouds gather above while torrential rains descend on condensation followed by storm, lightning and thunder.

Thick clouds carry negative charge which gradually builds up. With excessive charge build-up, it has to be relieved by an electrical discharge i.e. lightning within the cloud or from cloud to earth. The brightest lightning pulses are from the earth to the cloud i.e. travelling up. Each lightning stroke leaves a mass of heated air. The sudden expansion of air generates a series of wave-like vibrations. We call it thunder when it reaches our ear. As the speed of light is much faster than that of sound, we see lightning first and after a while, we hear the thunder.

A thunderstorm arises from intense convectional instability and is associated with lightning and thunder. When a thunderstorm grows in intensity, it leads to tornado. As mentioned before, tornadoes, typhoons/and cyclones are the same weather phenomenon with devastating power. Tornadoes are frequent in central and southern USA, Bangladesh and coastal areas of India such as Orissa and Andhra Pradesh. Cyclones occur in the tropical countries in the form of rotating storm starting from low pressure and developing into depression, deep depression and finally severe cyclone.

Tropical cyclones have wind velocities of the order of 120 km. or more. Each year cyclones from the Bay of Bengal and Arabian Sea affect various parts of India, Bangladesh and Mynamar. These develop during post-monsoon periods causing great havoc in the coastal regions of Andhra Pradesh, Orissa, West Bengal, Bangladesh and Arakan coast of Mynamar. The storms raise sea level by about 25 ft. causing flash floods in the coastal areas and damaging buildings, railway bridges, etc. The super-cyclone that hit Orissa in October, 1999 is the latest example.

## 2.4 ORIGIN AND EVOLUTION OF LIFE

For one-third of its history the planet Earth lay barren and lifeless under its canopy of air. Then some 3.0 billion (3000 million) years ago the first life form appeared as blue-green algae on the surface of the ocean. This happened probably by synthesis of organic compounds—nucleic acids by intense sunlight, ultra-violet radiation from the sun and carbon dioxide from surrounding air. The procession of life forms started via the route of evolution—lower plants, higher plants, lower animals, higher animals and finally man. The lower plants evolved into higher plants which generated oxygen by photosynthesis and the oxygen stock was built up in the atmosphere. This continued for 3 billion years—plants migrated from the seas to land. Then came animals—simpler forms first and then more complexes forms. And man came last of all some 50 million years ago when plants and animals provided the most hospitable environment. The process of evolution is still continuing—more and more superior species of plants and animals evolved in course of time replacing others which failed to adapt and survive for survival as a matter of natural selection.

Diversity is characteristic of living organisms. Our earth supports some 5 to 10 million species of plants and animals which are the products of 3 billion years of evolution involving mutation (genetic variation) and natural selection.

## 2.5 NATURAL/BIOGEOCHEMICAL CYCLES

Within an ecosystem (*see* next Chapter) there are dynamic relations between the living forms and their physical environment, i.e. rocks, air and soil of the earth (geo-). These relations are found as natural or biogeochemical cycles which involve continuous circulation of the essential elements and compounds required for life from environment to organisms and back to environment. The natural cycles and ecosystems function in a balanced manner which stabilises biosphere and sustains the life processes on earth.

### 2.5.1 The Geologic Cycle

The Geologic cycle means recycling of the earth's crust. According to the Plate Tectonic Theory, the earth's surface and interior processes are closely related. The lithosphere is subjected to continuous creation and destruction due to tectonic plate interactions giving rise to mountains in some places and depressions in some other places. It was initially composed of igneous or primary rocks due to cooling of magma and molten lava erupted from the interior of the earth. Furthermore, the earth's crust is constantly exposed to weathering forces viz. wind, rain and sun. These strip the land surface and carry sediments to the seas, oceans. The huge load of sediments carried to the seas and oceans gradually get cemented at the bottom and compacted to form sedimentary rocks.

The sequence: igneous rock–sedimentary rock–igneous rock (by flow of magma from the earth's core to the surface) is known as the Geologic Cycle as it is related to geologic processes.

### 2.5.2 The Hydrological Cycle

This cycle helps in exchange of water between air, land, sea, living plants and animals. About one-third of the solar energy absorbed by the earth is used to drive the hydrological

cycle—massive evaporation of water from the oceans, cloud formation and rainfall which gives us our supply and reserves of fresh water.

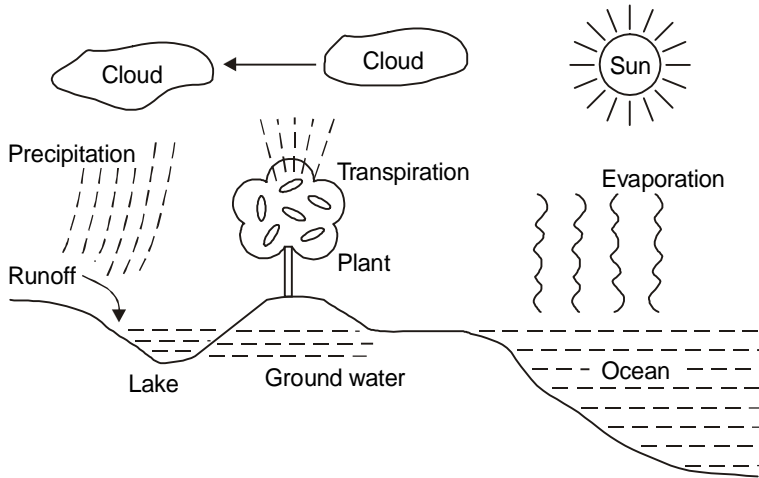

**Fig. 2.2** The hydrological cycle

At freezing temperature rainwater freezes into snow and forms hail in presence of strong wind. Water as rain, snow and hail is precipitated on land and water surfaces. On land surfaces water seeps into the soil and is stored as ground water. The natural water level or water table exists below the ground. The water table is supported by the underlying clay and rock strata. Ground water does not remain static but moves in various directions. It moves up and reaches soil surface where it is drawn by plant roots.

Another important ground water resource is the aquifers. This exists above impermeable rock strata—water percolates through porous rocks and forms these underground lakes or reservoirs. From the latter water can be pumped by digging tube wells and extracted by sinking wells.

When there is good rainfall, all the rainwater on land does not percolate into the soil. Surface water (run-off) flows into streams, rivers, seas, lakes and reservoirs. Normal evaporation from the oceans exceeds precipitation by 10 per cent. This excess 10 per cent moves as water vapour over land surface and balances the hydrological cycle. Plants absorb ground water by root pressure and transpirational pull but give off excess water through leaves by the process of transpiration. Thus water vapour level in the atmosphere is balanced and at the same time ensures conduction of water and dissolved mineral salts throughout the plants.

Thus the hydrologic cycle consists of a balanced continuous process of evaporation, transpiration, precipitation, surface run-off and ground water movements.

### 2.5.3 The Oxygen Cycle

Oxygen is vital for life in the biosphere. It is a major component of all living organisms. It is drawn by man and animals during aerobic respiration from air but released by plants during photosynthesis setting up the oxygen cycle. The oxygen cycle is based on exchange of oxygen among the environmental segments—atmosphere, hydrosphere, lithosphere and biosphere. It plays an important role in atmospheric chemistry, geo-chemical transformations and life processes.

*Combustion reactions:*

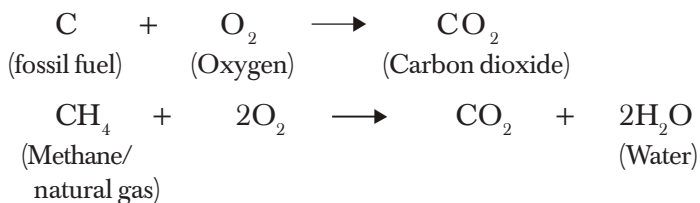

*Weathering processes of minerals:*

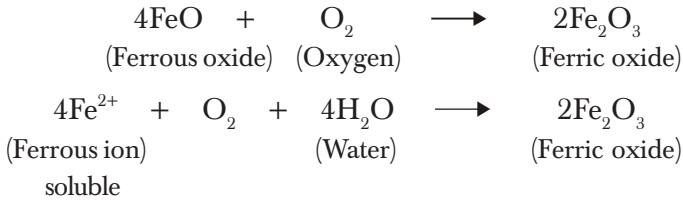

In the early stage of the earth, soluble ferrous iron consumed bulk of oxygen giving large deposits of ferric oxide as shown in the above reaction.

Green plants return oxygen to the atmosphere through photosynthesis:

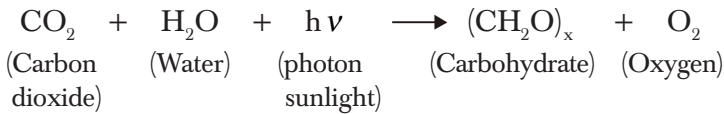

#### 2.5.4 The Nitrogen Cycle

Nitrogen and its compounds are essential for life processes in the biosphere. There is continuous exchange of nitrogen within the ecosystems operating the nitrogen cycle. Proteins produced by plants and animals in their metabolic processes are organic compounds of nitrogen. The major load of nitrogenous organic residue in soil originates from death and decay of plants and excreta of animals. These organic residues in soil are taken up by various soil micro-organisms for their metabolism which give products such as ammonia, nitrates and nitrites. Plants absorb nitrates from soil and re-enter the nitrogen cycle. Some soil micro-organisms break down soil nitrate into nitrogen by denitrification process while others transform nitrogen into soluble nitrogen compounds (*see* Fig. 2.3. The Nitrogen Cycle).

### 2.5.5 The Carbon Cycle

As carbon is the backbone of biological chemistry, the carbon cycle is a very important chemical cycle. The atmosphere is the minor reservoir of carbon dioxide while the oceans are the major reservoir, containing as much as 50 times more as that of air where it is stored as bicarbonate mineral deposit on the ocean floor. The latter regulates the carbon dioxide level in the atmosphere. The cycle operates in the form of carbon dioxide exchanging among the atmosphere, biosphere and the oceans (Fig. 2.4). The Carbon dioxide balance sheet per year is given:

- (i) emissions by fossil fuel 20 billion tons,
- (ii) emissions by deforestation and changes in land use 5.5 billion ton,
- (iii) uptake in the oceans 5.5 billion tons,
- (iv) uptake by carbon dioxide fertilization, i.e. photosynthesis 7.3 billion tons.

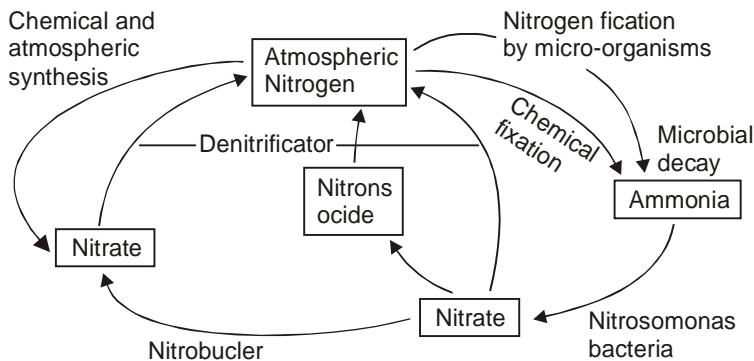

**Fig. 2.3** The nitrogen cycle

Thus there is a net increase of carbon dioxide in the atmosphere of 11 billion tons per year. This can be reduced by 50 per cent if we can stop deforestation (Fig. 2.5).

The atmosphere contains 2700 billion tons of carbon dioxide; biosphere, vegetation and soil about 6600 billion tons and the oceans about 1,36,000 billion tons of carbon dioxide.

$\text{CO}_2$  = Carbon dioxide  
 $\text{HCO}_3^-$  = Bicarbonate  
 $\text{CO}_3^{2-}$  = Carbonate

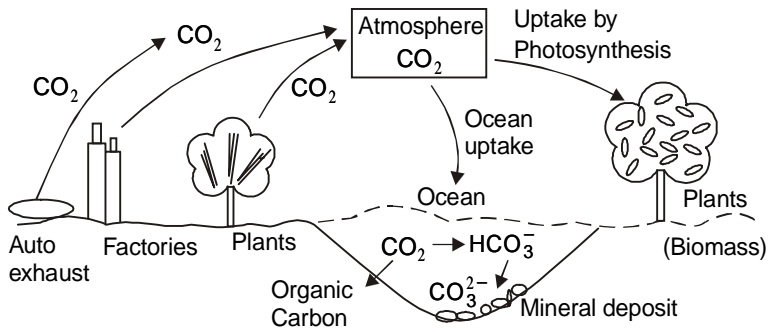

Fig. 2.4 Sources and sinks of carbon dioxide

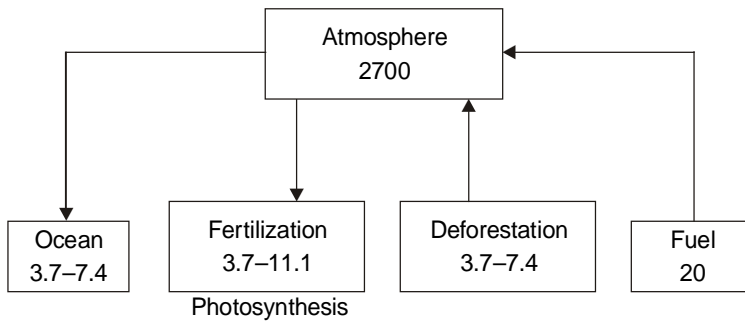

Fig. 2.5 Important fluxes of carbon dioxide (in billion tons)

### 2.5.6 The Phosphate Cycle

Phosphates are necessary for the growth and maintenance of animal and human bones and teeth while organo-phosphates



are required for cell division involving production of nuclear DNA (deoxyribonucleic acid) and RNA (ribonucleic acid).

Phosphate minerals exist in soluble and insoluble forms in rocks and soil. Plants absorb inorganic phosphate salts from soil and change them into organic phosphate. Animals obtain their phosphate by eating plants. After death and decay, plants and animals return phosphates to the soil. Bulk of the phosphate in soil is fixed or absorbed on soil particles but part of it is leached out into water bodies.

The natural phosphate cycle is affected by pollution, mainly from agricultural run-off containing superphosphate and also from domestic sewage. Phosphate pollution of rivers and lakes is the cause of algal bloom (eutrophication) which reduces dissolved oxygen in water and disrupts the food chain. The phosphate cycles on land and in water are shown in Figures 2.6 and 2.7.

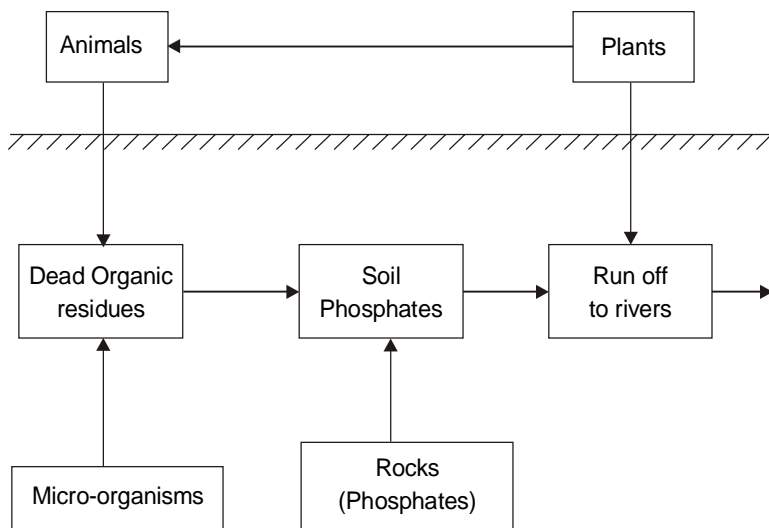

**Fig. 2.6** The phosphate cycle on land

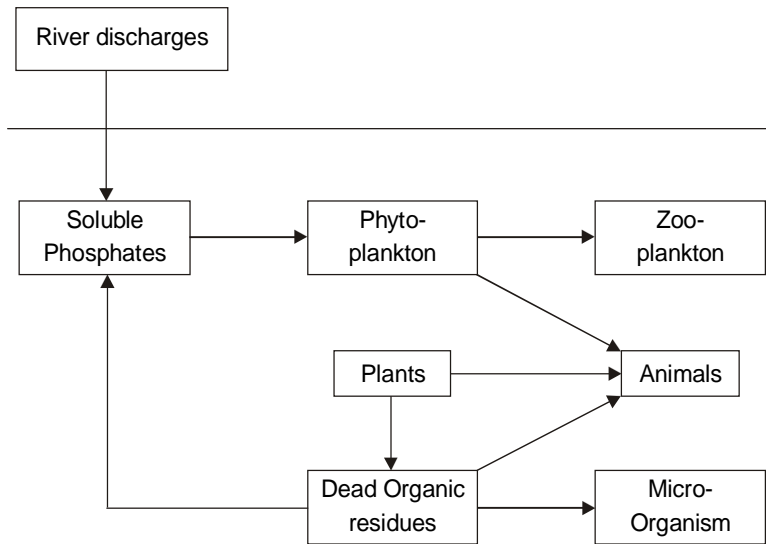
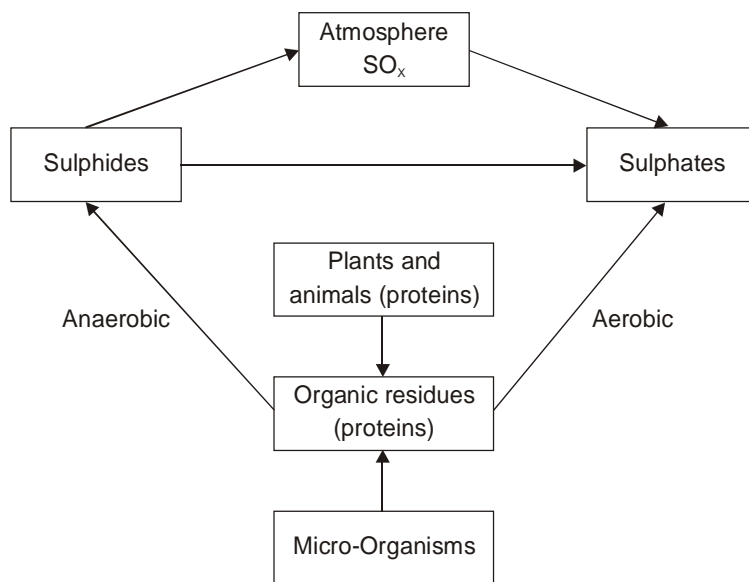

**Fig. 2.7** The phosphate cycle in water

### 2.5.7 The Sulphur Cycle

Sulphur and its compounds are required by plants and animals for synthesis of some amino acids and proteins. Some sulphur bacteria act as the media for exchanges of sulphur within the ecosystems. The sulphur cycle (Fig. 2.8) illustrates the circulation of sulphur and its compounds in the environment.

The sulphur oxidation process is shown in the upper half of the cycle. The lower section shows the conversion of sulphate into plant and cellular proteins and the decay of dead plant and animal material by bacterial action. In polluted waters under anaerobic conditions hydrogen sulphide is produced by bacteria giving deposits of iron sulphide. In unpolluted waters under aerobic conditions the sulphur bacteria transform sulphides into sulphates for further production of proteins.



**Fig. 2.8** The sulphur cycle

### Key Terms and Concepts (Glossary)

*Atmosphere:* The invisible layer of colourless and odourless gases which surrounds the earth, sustains and protects life on earth. It is mainly composed of oxygen (21%), nitrogen (78%) and traces of carbon dioxide, water vapour, etc. It extends to above 500 km. above sea level.

*Big Bang:* At the beginning, the entire matter of the Universe was condensed into a cloud of gas and dust. This underwent consecutive contraction and expansion and finally exploded with “Big Bang” about 6.5 billion years ago. The stellar body burst into several fragments which were thrown into space at tremendous speed. This gave rise to the solar systems including ours. The Earth is a tiny part of our solar system.

*Biogeochemical cycles:* There is continuous circulation of chemical elements (carbon, oxygen, sulphur, phosphorus, etc.) among biological or living organisms and their geographical

environment (atmosphere/lithosphere). This is known as biogeochemical cycle.

*Biosphere:* Composite environment consisting of lithosphere, hydrosphere, atmosphere, micro-organisms, plants, animals and man. Biosphere and environment have close interaction with each other.

*Carbon cycle:* Operates in the form of carbon dioxide exchanging among the atmosphere, biosphere and the oceans.

*Cyclone:* Tropical storm in which the wind rotates around a centre of low atmospheric pressure anti-clockwise in the Northern hemisphere and clockwise in the Southern hemisphere with wind speed about 100 km. or more. Cyclones from the Bay of Bengal and Arabian sea affect various parts of India, Bangladesh and Mynamar.

*Earth:* The planet of our solar system and a part of the stellar body at the moment of the Big Bang. The Earth provides the optimum environment for origin and evolution of life forms and natural ecosystems with rich biodiversity. Later on, man-made activities polluted and damaged the environment.

*Geologic cycle:* Recycling of the earth's crust. The earth's crust is initially formed by igneous rocks due to cooling of magma and molten lava erupted from the interior of the earth. It is then exposed to the weathering forces and the resulting sediments are carried to the rivers and seas where they get cemented and form sedimentary rocks. This is the rock cycle or geologic cycle.

*Lithosphere:* The earth's crust, made of native rocks at different stages of weathering and soils of different kinds, etc.

*Nitrogen cycle:* Continuous exchange of nitrogen within the ecosystem: air–soil–air. Thus nitrogen from air is fixed as ammonia, and then nitrate in soil. From soil it is decomposed into nitrite, nitrate and finally nitrogen and recycled back to the atmosphere.

*Hydrological cycle:* Based on evaporation of water from the oceans and seas by solar radiation, cloud formation, rainfall on land and sea and final return to the sea. This gives us our supply and reserve of fresh water.

*Phosphate cycle:* Circulation of the chemical element, phosphorus among soil, plants, animals and soil.

*Sulphur cycle:* Circulation of sulphur and its compounds in the environment: air–soil–plants–animals–soil.

*Thunderstorm:* Violent winds associated with lightning and thunder.

*Tornado:* As a thunderstorm grows in intensity, it leads to tornado. Tornadoes are frequent in central and southern USA, Bangladesh and coastal areas of India.

## QUESTIONS

1. How was the planet Earth formed and evolved?
2. What are the components of the Earth or environmental segments?
3. Comment on the origin and evolution of life.
4. Discuss oceanic and continental impact on climate.
5. Give an account of the natural cycles of environment.
6. Write notes on:
  - (a) Hydrological cycle
  - (b) Oxygen cycle
  - (c) Nitrogen cycle
  - (d) Phosphate cycle
  - (e) Sulphur cycle
  - (f) Carbon cycle.



---

# Ecosystems

## 3.1 ECOLOGY AND ECOSYSTEM

The word “Ecology” was coined by a German biologist in 1869 and is derived from the Greek word, “Oikos” meaning “House”. Ecology is the branch of Science that deals with the study of interactions between living organisms and their physical environment. The latter are closely inter-related and they have continuous interaction so that any change in the environment has an effect on the living organisms and vice-versa. Any unit or biosystem that includes all the organisms which function together (biotic community) in a given area where they interact with the physical environment is known as ecosystem.

The ecosystem is the functional unit in ecology as it consists of both the biotic community (living organisms) and abiotic environment. The latter have close interaction, essential for maintenance of life processes. The interaction is conducted by energy flow (solar energy) in the system and cycling of materials (natural cycles).

From biological points of view, the ecosystem has the following constituents:

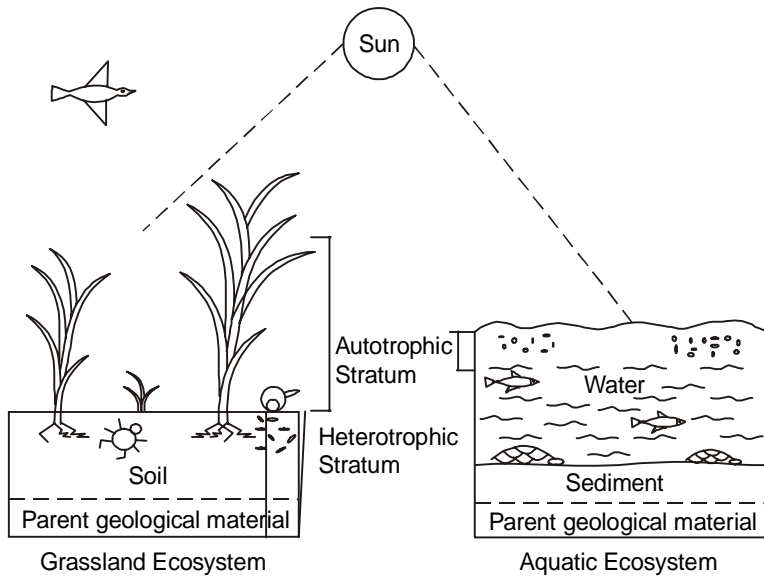

**Fig. 3.1** Grassland and pond ecosystem

- (i) inorganic substances (carbon, nitrogen, carbon dioxide, water, etc.) involved in natural cycles;
- (ii) organic compounds (proteins, carbohydrates, humic substances, etc.);
- (iii) air, water and substrate environment including the climatic regime and other physical factors;
- (iv) producers, autotrophic (i.e. self-sustaining organisms, main) green plants that can manufacture food from simple inorganic substances;
- (v) heterotrophic (i.e. depending on others for nourishment) organisms, mainly bacteria, fungi and animals which live on other organisms or particulate organic matter;
- (vi) micro-consumers, decomposers, mainly, bacteria, fungi which obtain their energy by breaking down dead tissues or by absorbing dissolved organic matter,

extracted from plants or other organisms. The decomposers release inorganic nutrients that are utilised by producers. They also supply food for macro-consumers or heterotrophic organisms bacteria, fungi and (animals) and often excrete hormone-like substances that inhibit or stimulate other biotic components of the ecosystem.

Typical profiles of a grassland ecosystem and of a pond ecosystem are shown in Fig. 3.1.

The common features of all ecosystems—terrestrial, freshwater, marine and agricultural—are the interactions of the autotrophic and heterotrophic components. The major autotrophic metabolism occurs in the upper “green belt” stratum where solar energy is available while the intense heterotrophic metabolism occurs in the lower “brown belt” where organic matter accumulates in soils and sediments.

### 3.1.1 Biomes

The Biome is a very large land community unit where the plant species is more or less uniform. It provides a basis of natural ecological classification. The main Biomes of the world are the Tundra, Temperate, Coniferous forest, Deciduous forest, Temperate grassland, Tropical Savanna, Desert and Tropical Rain Forest.

The *Tundra Biome* is in the polar region (north of latitude 60° North)—it is characterised by absence of trees, dwarf plants and an upper ground surface which is wet, spongy and rough.

*Temperate Coniferous Forest Biome* Coniferous forest occurs in cold regions with high rainfall, long winters and short summers.

*Temperate Deciduous Forest Biome* These are high altitude regions about 3000–4000 metres above sea level as in the Himalayas. Here pines, fir and juniper trees are found.



*Temperate Grassland Biome* This type of grassland occur where there is about 25 to 75 cm of rainfall per year. Such grasslands are found as tall grass prairies, short grass prairies of North America and also in South America, steppes of Southern Russia and Asia.

*Tropical Savanna Biome* These are tropical grasslands with scattered drought-resistant trees. These are found in eastern Africa, Australia and South America.

*Desert Biome* These are found in very dry environment where temperature changes from very hot to very cold.

*Tropical Rainforest Biome* These occur near the equator and offer the most diverse communities on earth with fairly high temperature and humidity. The annual rainfall is more than 200–225 cm. Here one finds dense vegetation consisting of tall trees covered with creepers and orchids, numerous herbs and shrubs. Tropical rainforest is the habitat of numerous vertebrate and invertebrate animals.

### 3.1.2 Ecosystems

Ecosystems of the world are studied on the basis of their principal habitats. Among the environmental segments, lithosphere and hydrosphere are the major habitats for a wide variety of flora and fauna.

#### *Land-based Ecosystem*

Land (terrestrial) ecosystems depend largely on the climate and soil. Higher plants and animals have evolved on land. For example, seed plants, insects, warm-blooded vertebrates and micro-organisms dominate on land now. The major terrestrial communities consist of herbaceous plants, shrubs, grass and also woody trees besides numerous insects, anthropods, birds, etc.

### *Marine Ecosystem*

Oceans occupy 70 per cent of earth's surface, offering habitat to numerous plants, (mainly algae), animals like zoo plankton, shrimps, oysters, fishes, reptiles, birds and mammals. They serve as the sink of a large quantity of run-off and wastes from land.

Marine water has a high salt content (about 3.5% by weight) and poor fertility due to lack of nitrates and phosphates as compared to fresh water. Marine life is abundant near the shore and in the continental shelf. The species include commercial fishes, large sea mammals like whales and seals.

### *Freshwater Ecosystem*

Freshwater bodies (ponds, lakes, rivers, springs) are rich in nutrients (nitrates, phosphates) and provide good habitat for phytoplankton, zooplankton, aquatic plants and fishes.

### *Wetland Ecosystems*

Wetlands are transitional lands between terrestrial and ecosystems where water stands at 2.5 to 300 cm during most of the year. They include valuable natural ecosystem harbouring a wide variety of plants, animals, fishes and micro-organisms. They are at present in danger due to increasing urbanization as in case of eastern part of Calcutta.

### *Mangroves (Forest between Land and Sea)*

Mangroves are important forest communities in tidal zones or equatorial and tropical coasts. For example, the Sunderbans in the Gangetic estuarine delta touching the Bay of Bengal offer important mangroves, habitat of wild animals including Royal Bengal Tiger and of interesting plant species.

### 3.2 FOREST ECOLOGY

Plants have been dominating the earth for about 3.0 billion years. They have the unique art of manufacturing their own food by photosynthesis from nature and the rest of the living world depends on them for their food and sustenance. Plants constitute 99 per cent of earth's living species and the rest 1 per cent include animals and man who depend on the plant world for their food. If this ratio (99 : 1) is disturbed by elimination of plants (i.e. deforestation), then the natural balance will be lost and the entire living world will suffer most. The dynamic balance is among plants (*producers*), bacteria and micro-organisms (*decomposers* who decompose mineral salts in soil into elements which are cycled back into plants) and animals plus man (*consumers*). Once this dynamic balance is upset, there is ecological crisis whereby the entire biosphere is in danger.

Forests are renewable resources and have a key role in improving the quality of environment by exerting beneficial effect on the life support system. Moreover, forests also contribute much to the economic development of the country by providing goods and services to people and industry. They are the treasure house of valuable plant and animal genes and medicinal plants, most of which are yet to be discovered. Hence tropical forests, in particular, are regarded as bio-reserves. Our ancient civilisation flourished in forests, where Indian philosophy was built up by our "rishis" (seers).

It is well-known that forests play a vital role in the life and economy of all forest-dwelling tribes. They supply food (tuber, roots, leaves, fruits and meat from animals and birds), medicinal herbs and other forest products for commercial use which provides for forest-based subsistence.

Around 3000 BC India had about 80 per cent forest cover. During the Maurya period of history emperor Chandra Gupta Maurya and later his grand son Ashoka adopted the policy of

tree-plantation. Emperor Ashoka also ordered the establishment of the first wildlife *sanctuaries* (*abhayaranyas*). Carvings on stone pillars from this era show how wild animals were treated with medicine and care.<sup>1</sup>

But waves of migrants came to India from middle-east countries which were deserts and tree-less and they changed the whole landscape. During the Moghul period again the picture was reversed as the Moghuls came from tree-less countries—they converted forests into agricultural lands. During the British period the rate of forest conversion into agricultural land continued. They also exploited forests for timber for laying communication system particularly after 1867 (India's first war of Independence/Sepoy Mutiny). After our Independence in 1947 the situation did not improve rather the trend continued to draw revenue from forests. The net result is that the forest cover has dwindled from 80 per cent to about 12 per cent in 5000 years. India has been losing 1.3 million hectares (1 ha = 2.5 acres) of forests each year.

The main causes for forest destruction are human population and livestock (cattle, buffaloes, goats, sheep) population explosion. These enhance the demand for timber and fuel wood (for man) and grazing land (for livestock). At the global level wood consumption is 46 per cent for industrial and 54 per cent for firewood purposes. In developing countries like India the picture is reverse—82 per cent for firewood and 18 per cent for industrial purpose. The present requirements in India (in 2000) are—78 per cent for fuel wood, 16 per cent for timber and 6 per cent for pulpwood (for paper industry).

### 3.2.1 Forest Conservation

The Forest Policy of the Government of India (1952) laid down that one-third (33 per cent) of our land should be under forest

---

<sup>1</sup> Big hunting game by Hindu Kings in the earlier periods had caused destruction of wild life and forests.

cover. However, this has not been followed seriously with the result that the present forest cover has gone down to about 12 per cent. We have almost reached a critical state which must be remedied now before it is too late for our own survival. The remedial measures (conservation) have been suggested as follows:

- (i) *Conservation of Reserve Forests*: These are areas where our major water resources are located, viz. the Himalayas, Western and Eastern Ghats and areas like reservoirs, National Parks, Sanctuaries, Biosphere Reserves, etc. These must be protected and no commercial exploitation be allowed in these areas. This is an important conservation strategy.
- (ii) *Limited Production Forests*: These are less fertile areas at high altitude (more than 1000 metres) with hilly environment. Here the health of the forests should not be damaged and only limited harvesting with utmost care be allowed.
- (iii) *Production Forests*: These are forests on the plains and their productivity can be enhanced by proper management. These should be maintained to make up for the losing forest cover.
- (iv) *Social/Commercial Forestry*: Such forestry is meant for supplying goods and services to meet the ever-increasing demand for firewood, fodder, food, fertiliser, fibre, timber, medicine, etc. or for industrial purposes such as timber, plywood, matchwood, fibre board, paper and pulp, rayon, etc. The main idea is to remove pressure on natural forests for these requirements.

Social forestry is based on public and common land (private) to produce firewood, fodder, fruit and small timber for rural people.

The programme should be conducted by a co-operative system including farmers, tribals, panchayats and NGOs (Non-government organisations), etc. Degraded lands should be

utilised for social forestry for firewood, whereby the quality of land improves in course of time.

Massive afforestation should be done involving multi-purpose species of plants/shrubs so that every village/town/city is able to meet its requirements for firewood, fodder and small timber. Production/Commercial Forestry is intended entirely for commercial purposes to meet the needs of the forest-based industry. Fallow lands, not used for agriculture, grazing lands, etc. can be used for raising such plantations.

### **3.2.2 Biodiversity**

There may be about 10 million species of plants, micro-organisms and animals on earth while only about 1.5 million species are on record, i.e. identified so far. Among these the majority are insects (7,50,000), 41,000 are vertebrates (i.e. those having backbones or spinal columns), 2,50,000 are plants, 1,00,000 are fungi and the rest are invertebrates and micro-organisms.

Biological diversity or biodiversity involves genetic diversity among species as also between individuals and ecological diversity, i.e. number of species in a community of organisms. The existing species of plants and animals are the product of 3 billion years of evolution involving mutation, recombination and natural selection. Changes in environment, e.g. warm and cool periods exerted selection pressures and have been responsible for evolution of new species and extinction of others who could not survive in the struggle for survival. The dinosaur era is an example. These giant-sized animals dominated the earth for 130 million years and became extinct before the Ice Age.

Natural extinction, part of evolutionary process, has been accelerated by man-made extinction wave due to constant greed and need of man. By this time, 1 out of 10 million species has become extinct and each day we are losing one plant and one animal species. At this rate of extinction, the survival of man

himself is threatened. The *specide* (extinction of species) in which man is involved is more serious a crime than genocide (mass murder). In this context we may note our tradition. Charaks, the well-known ancient physician, was asked by his teacher to get a plant that was useless. He returned after a few days and reported that there was no such plant. One cannot imagine a situation if *Penicillium* was extinct before man could make use of it as an antibiotics or if *Cinchona* became extinct before quinine was discovered as a cure for malaria. It is, therefore, in our own interest that we should conserve our plant as well as animal and micro-organism (fungus and bacteria) wealth. There is a growing realisation all over the world about the urgent need to conserve the *biological diversity*.

The United Nations Earth Summit (Rio de Janeiro, 1992) adopted the Treaty on Biodiversity whereby countries agreed to conserve the Biodiversity—the living natural resources (plants, animals, microbes) for the welfare of mankind.

### 3.2.3 Sustainable Ecosystem

The developing countries face to-day critical situation on economic and environmental fronts. For economic growth they have to give priority to agricultural industrial bases but at the cost of environment. The resource base, once depleted, sets in chain of environmental degradation which finally weakens the economy. Our population explosion remains the core issue. Our development policy should be such that the ecosystem is sustainable, i.e. it contains the element of renewability. This requires sound management strategy which ensures the continuation of socio-economic development in the long run.

The important components of sustainable development/ ecosystem are:

- Population stabilisation,
- Integrated land use planning,
- Conservation of bio-diversity,

- Air and water pollution control,
- Renewable energy resources,
- Recycling of wastes and residues, and
- Environmental education and awareness at all levels.

Sustainability is thus effecting a balance between stability, equity and diversity.

### **Key Terms and Concepts (Glossary)**

*Biodiversity:* Genetic variety among individual species, between species and ecodiversity i.e. number of species in a community of organisms. There are about 10 million species of plants, micro-organisms and animals on earth. These living natural resources are essential for the welfare of mankind. The Earth Summit (1992) adopted the Treaty on Biodiversity for conservation of Biodiversity for the benefit of mankind.

*Biomes:* Large land community unit where the plant species is more or less uniform or homogeneous. It forms the basis of natural ecological classification—e.g. Tundra, Temperate, Corniferous forest, Grassland, Tropical Savana, etc.

*Ecology:* Branch of science that deals with the interactions between living organisms and their physical environment.

*Ecosystem:* Any unit that includes all organisms which interact with their physical environment as a whole (biotic community) is know as Ecosystem. The size of such system may vary from small one to a vast geographical area. The Ecosystem consists of both biotic (living organisms) community and abiotic (non-living) environment and is the functional unit in ecology.

*Forest Ecology:* Forests comprise large land area with natural assembly of mainly trees and shrubs as well as birds, animals and forest dwellers. They play vital role in the environment and also economy of the country.

*Mangroves:* Maritime vegetation (shrubs and trees) between land and sea. These are important forest communities in tidal zones



in tropical and equatorial coasts e.g. in the Sunderbans, West Bengal. These are specially adapted to saline water (sea water) swamps in the estuaries of big rivers in Asia and America.

*Sustainable Ecosystem:* The resource base of an ecosystem land, forest, water, etc.—can be stabilised if it contains an element of renewability and self-regulation.

This is sustainable ecosystem. The ecosystem is destabilised by man-made activities such as deforestation, industrialisation, etc. which brings about environmental degradation and adverse effects on human survival. Sustainable ecosystem is essential for economic development of a country and for the benefit of mankind.

*Wetland:* Natural ecosystem having the properties of both terrestrial and aquatic systems where the land remains submerged (water depth 2.5 to 200 cm) for most of the year. Wetlands appear as swamps, bogs and marshes. They also include estuaries and deltas, mangroves, waterlogged paddyfields and shallow fisheries. Wetlands play important role in ground water recharging, flood control and sewage treatment.

## QUESTIONS

1. What do you mean by Ecosystem? Give examples.
2. Illustrate land ecosystem and also an aquatic eco-system.
3. Discuss the role of forests in the biosphere.
4. Trace the factors leading to deforestation.
5. How are the forests related to Biodiversity?
6. Explain why conservation of forests and biodiversity are important for the welfare of mankind.
7. What is sustainability and sustainable development? What are its components? How can it be ensured?



---

# Population and Environment

## 4.1 HUMAN POPULATION AND DISTRIBUTION

Population is intimately related to environment. The Human population has grown faster in the 20th century than ever before. World population doubled in 40 years between 1950 and 1990 to cross five billion. The developed countries account for 1.5 billion and developing countries 3.5 billion population. By 2010 AD the population has touched 6.3 billion and by 2000 it will grow to 7 billion (one in every seven will be an Indian). World population is growing by 92 million every year, roughly adding population of Mexico.

It is interesting to note that it took about 2 million years for the world population to become 1 billion (1830), 100 years for 2 billion (1930), 30 years for 3 billion (1960), 15 years for 4 billion (1986) and 11 years for 5 billion (1997). The population stands at 6.3 billion (2000) and is estimated to be about four the times around 22.5 billion in 2100. In developed countries the population is likely to be less than double while in developing countries like India about four times (2100).

The statistics for India is of serious concern. Between 1901 and 1951 India's population grew from 238 million to 361

million an increase of 52 per cent in 50 years. Between 1951 and 1981 it expanded from 361 to 685 million. Post-independent India in 35 years (1947–81) literally added a second India, i.e. doubled its population. In 2000 it has touched 1 billion mark and is the second most populous country, next to China (May 11, 2000). We have been overwhelmed by population explosion since 1980.

According to 2001 Census Report, India has joined *one billion club*, with population of 1.02 billion, ranking second to China (1.265 billion). By 2025 India is likely to overtake China and will be the most populous country in the world. It has to be noted that whereas Chinese population is under control with growth rate of 0.7 per cent, India's population growth rate is 1.8 per cent at present. While China with its strong economy can support its 1 billion plus population, India cannot afford to do so, being one of the poorest countries in the world (400 million people live below the poverty line). We are overwhelmed by the population explosion since 1980 and that remains the core issue of our environment and economy.

*Indian population statistics*

1901	1951	2001
238 million	361 million	1020 million

#### 4.1.1 Distribution

For historical and other reasons people are not uniformly distributed. USA and Canada have a population of 250 million; South America and the Soviet Union (CIS) have the same population. Africa and Western Europe have about 500 million people; East Asia, i.e. China, Japan and Korea have more than 1 billion while South Asia is the most populous region, 1.5 billion (India, Bangladesh, Pakistan more than 1 billion). India is adding every year the population of Australia at the current rate.

### 4.1.2 Population Density

The density of population within a country gives a rough idea of the effect of population on natural resources. In general, lightly populated countries retain more of their original vegetation and wild animal populations than those with dense human population. Thus Australia (4 people/sq. km.) is not likely to face wood or water shortage compared to Bangladesh (1800 people/sq. km.). However, total population size or population density cannot accurately predict the impact of environmental damage on the economy of a country. Some of the most crowded countries in East and South Asia are the most prosperous, e.g. Taiwan, South Korea, Hong Kong and Singapore where the population density is 1000 people/sq. km.

Some crowded countries can even manage to produce all their own food. U.K. (600 people/sq. km.) exports food while Brazil (44 people/sq. km.) has to import food. Again, Europe has all the timber and fresh water it requires but Africa (95 people/sq. km.) has acute shortage of both these items.

Some differences among countries as stated above are due to differences in their economies—sustainable and non-sustainable. The countries with stable population enjoy sustainable economy and are prosperous—the developed countries belong to this category. Similarly countries with fast population growth suffer from non-sustainable economy and face serious problem.

### 4.1.3 Age Structure

In contrast to the developed countries India has a pyramidal distribution of age-wise population distribution. Children constitute 40 per cent, youth 33 per cent, middle-aged persons 21.5 per cent and old 6.2 per cent. Such a structure with predominantly young people up to 34 years (73 per cent) favours fast population growth. While India has a youthful age (reproductive group) structure, in the Western countries the

population has much less youthful age structure which slows the population growth.

The ratio of people over 65 and under 15 to the rest of the population is *dependency ratio*. This gives a measure of the economic impact of the population age structure. People above 65 and below 15 contribute little to the economy and must be supported by the working population. Dependency ratios are rising in developing countries. High dependency ratios, as in India, have adverse effect on the economy. This explains why working Indians have lower standard of living compared to developed countries.

#### **4.1.4 Doubling Time**

The period within which the population of a country doubles is known as its doubling time. This gives some idea of the adverse effect of population growth. Most developed countries have doubling times of more than 100 years while in developing countries, as in India, population has doubling time less than 25 years. It is absurd to double our resources-water, food and energy in 25 years and tackle the pressure on schools, hospitals, police protection and other vital services.

#### **4.1.5 Fertility Rate**

The general fertility rate of a population is the number of babies born to 1000 women of the reproductive age. The rate of population growth, however, is based on the average age of first reproduction. Thus whether a population is increasing, decreasing or stationary is more correctly estimated from the age-specific fertility rate, the number of births per 1000 women of each reproductive age group. The fertility rate for India and other developing countries is about 3.0 while that for the Western countries is below 1.5.

#### 4.1.6 Infant Mortality/Life Expectancy

The death rate is generally expressed as the number of deaths per year for every 100 people. Modern medical science has helped to reduce the death rate but not the birth rate. Death control without birth control has led to population explosion.

Infant mortality is one of the most tragic indicators of poverty of a country. It also sets the parameter of *life expectancy*, i.e. the average number of years that a new-born baby is expected to survive. Progress in medical science has in general increased the life expectancy. In 1900 life expectancy was 46 years in the developed countries because the infant mortality was high, i.e. 40 per 1000. The situation improved much in 1984 in these countries when the life expectancy rose to more than 70 years as the infant mortality dropped to about 10 per 1000. The world's highest life expectancy is that of Japan (79 years) which enjoys highest literacy and fairly high standard of living. In the developing countries high infant mortality accounts for lower life expectancy. Furthermore, lack of the basic amenities of life (access to clean water, nutritious food and elementary education) is responsible for life expectancy of 45 years in most of Africa whereas in South America and East Africa life expectancy rose to 65 years.

It is on record that in developing countries 1 in 3 children is malnourished and about 3 million children die annually from diseases that could be avoided by immunization. And moreover, 1 million women die each year from preventable reproductive health problems.

#### 4.1.7 Carrying Capacity

The maximum population size that an eco-system can support under particular environmental conditions is known as the *carrying capacity*. In natural ecosystems with unlimited resources and ideal environment, species can multiply at a maximum rate. However, in actual practice, the population of a species

remains in check due to interaction of the inhabiting species as also finite nature of resources.

If the prevailing agricultural system produces X calories and if each person needs a minimum of Y calories to survive, then the carrying capacity of the system is given by X/Y.

It is an established fact that while foodgrain production can under optimum conditions increase arithmetically (1, 2, 3, 4, ...), population increases geometrically ( $2^2$ ,  $3^2$ ,  $4^2$  ...).

$$\frac{dN}{dt} = rN$$

Where  $dN/dt$  = rate of population growth  
 $N$  = population size, and  
 $r$  = specific growth rate

With doubling of population, resources do not double and hence set in a critical situation. If the population size far exceeds the carrying capacity by a wide margin, it leads to *population crash* when environmental conditions get degraded and lower the carrying capacity.

The earth weights about  $5.97 \times 10^{24}$  kg. If the present population growth continues for the next 5000 years, then the weight of human population itself will equal the earth's weight. In other words, another earth will have to be accommodated within this earth, which is totally absurd. This implies that man will run out of space and resources. Thus the present population growth will get more and more unfavourable for human survival as it will destroy the carrying capacity in the long run.

#### 4.2 POPULATION STABILISATION/ SUSTAINABLE DEVELOPMENT (INDIAN CONTEXT)

India accounts for 16 per cent of the world population but only 2.4 per cent of the land area. Hence per capita availability of

land in the country is 0.48 hectare as against 4.14 hectares in USA, 8.43 hectares in CIS and 0.98 hectares in China. Our population is concentrated in the river valleys (40 per cent in the Ganga basin). Man: land ratio in relation to arable land is only 0.27 hectares in India which is quite low for a predominantly agricultural country.

The concept of carrying capacity, as stated above, implies that only a limited number of people can be supported by the resources of a country. Due to demographic (population) pressure, economic pressures build up while cropland, grassland, woodland and fisheries that support the human population by supplying goods and services, are adversely affected. As people multiply, resources obviously shrink. The future population growth has to be related to the resource base in order to have sustainable development. Population stabilisation (i.e. keeping the population level low, preferably below 0.5 per cent) as in the developed countries) is the key to economic development and resource management. This is the success story of all developed countries.

Population explosion is a time-bomb which must be defused sooner the better. It is one of the major crises facing the nation. We have to break the vicious **P-triangle**—Population—Poverty—Pollution on an emergency basis for our own survival.

#### 4.2.1 Kerala Model

Kerala has earned the distinction of lowest birth rate among Indian states since 1960—25 per 1000 as against 33 per 1000, Indian average. It is comparable, as a state, to West Bengal—both are densely populated, both have emphasis on education and both are under similar political system of long periods of rule by left-oriented parties. But the comparison ends here. Kerala is poorer than West Bengal (per capita income, both urban and rural, less than West Bengal), less industrialised than West Bengal and has greater inequalities in income. Yet Kerala's birth rate is lower than that of West Bengal since 1960. This



belies the general feeling that greater industrialisation and incomes lead to lower birth rates. The success story of Kerala is explained below.

The reasons behind the low birth in Kerala are—higher age of marriage for women at 21 years (Indian average 17 years); higher female literacy rate 53 per cent (Indian average 13 per cent); greater emphasis on primary education (education budget 60 per cent spent on primary education/West Bengal 38 per cent); better public distribution system of food among 97 per cent of population; better health facilities in rural areas and greater success of family planning programmes. Thus Kerala shows the way to population stabilisation in India.

### 4.3 WOMEN AND ENVIRONMENT

Women, particularly poor village women, are the worst victims of environmental degradation. Their day starts with a *long march* in search for fuel, fodder and water. Many such women spend up to 10 hours a day fetching fuel, fodder and water. An average family in Karnataka village walks about 5 km. daily on average for collecting fuelwood only, equivalent to walking from Delhi to Bombay every year. In deforested hill and forests the treks are longer and more difficult. By lighting firewood in chullahs, they turn their kitchens into gas chambers where they spend 2-3 hours daily for cooking food. They are exposed to heavy fumes and smoke and suffer as much as a chain smoker smoking 20 packets of cigarettes a day.

Biomass plays a crucial role in meeting daily needs of the vast majority of rural households. The different forms of biomass are food, fish, fuel (firewood, crop wastes and cowdung); fodder, fertiliser for agricultural fields (cowdung, organic manure, forest wastes); building materials (timber and thatch) and medicines (herbs). The country's biomass base is affected by deforestation and loss of vegetation cover. It is the village women who are worst hit by deforestation

and devegetation (loss of vegetation cover). Similarly, the forest dwellers, viz. tribals and nomads those who wander from one place to another and have no fixed location, face total social destruction—they are converted into the uprooted lot of “*environmental refugees*”.

### 4.3.1 Woman Power

In the 18th century some 350 Bishnoi men and women from the Bishnoi community in Rajasthan were determined to protect their forest. They clasped the trees when the Maharaja of Marwar sent some wood-cutters along with soldiers to cut down those trees which were required for a brick kiln (furnace) to make slabs for his palace. But the group of men and women resisted by continuing to clasp the trees and finally they were hacked to death. This was the precursor (fore-runner) of the Chipko Movement two centuries later. (1983).

The women of the Garhwal hill region of UP were at the vanguard of the Chipko Movement (*see* Chapter 10). They organised and executed the movement with utmost sincerity and spread their base all over the Garhwal region. Thus organised woman power prevented further ecological crisis in the Himalayan region.

Another shining example of woman power was the case of Khirakot women in Almora district of UP Himalayas. A Kanpur contractor was setting up soapstone mines in the hills and thereby destroying the ecology of the region. The Khirakot women sprang into action—they got organised, stopped the work of the mines and also fought legal case against the contractor. Finally they won the battle, both legal and environmental and got the contractor’s license cancelled.

## 4.4 HUMAN DEVELOPMENT

The economic status of a country is normally judged by its Gross Domestic Product—GDP (consumerism, i.e. commodities

purchased per year, consumer durables, financial status). But since the nineties the United Nations introduced the concept of *Human Development Index*—HDI replacing GDP. This is an estimate of human resources development as measured by three parameters—life span, literacy and standard of living. It determines the quality of life in a country. All the countries in the world have been listed in terms of *HDI*.

The latest United Nations Report (2000) on Human Development and HDI list (Human Development Index) reveals some interesting facts and figures regarding the status of India in the world perspective.

India has moved up by four places from 132 to 128 in the HDI list while Pakistan ranks 135, Bangladesh 146, and Sri Lanka has moved up to position 84. Canada retains the top position (number one) for the seventh consecutive year while Japan has moved down from position number one to eighth during a span of 10 years. The HDI rankings of other countries in the high category are: Norway (number 2), USA (number 3), Australia (number 4), Sweden (number 5), Belgium (number 6), the Netherlands (number 7), Japan (number 8), Britain (number 9) and Finland (number 10).

According to the Report, even in the richest nations relative prosperity in some countries like USA has failed to improve lives. Although USA has the second highest per capita income among 18 richest nations (OECD, i.e. Overseas Economic Cooperation and Development countries), it has a fairly high poverty rate. The main reason is the prevalence of functional illiteracy (20 per cent).

In general, however, the deprivations cast their dark shadow over most of the world. *Some 1.2 billion people live below poverty line, with income less than one dollar a day; more than 1 billion people in the developing countries lack access to safe water and more than 2.4 billion people lack adequate sanitation.*

In the HDI list, India occupies 128th position. Per capita GDP (Gross Domestic Product) values for India (\$ 300) are

less than 1.5 per cent of those of Japan (\$ 24,000) and USA (\$ 20,000). In spite of remarkable progress in science and technology, India remains one of the poorest countries in the world, with 40 per cent population living below the poverty line, 44 per cent below literacy line and 25 per cent without access to proper health care.

### **Key Terms and Concepts (Glossary)**

*Carrying Capacity:* The maximum population that can be sustained by an ecosystem.

*Doubling Time:* The period within which the population of a country doubles. The doubling time is more than 100 years in developed countries and 25 years in India and other developing countries.

*Dependency Ratio:* Ratio of people 65<sup>+</sup> (over 65) and 15<sup>-</sup> (under 15) to the rest of the population. People in this age group require support by the working population. High dependency ratio, as in India and other developing countries, is an index of poor economy of the country. Working Indians have lower standard of living compared to the developed countries.

*Fertility Rate:* Number of babies born to 1000 women of the reproductive age. The fertility rate for India is about 3.0 and below 1.5 in the western countries.

*Human Development:* The development of human resources so that the quality of life reaches a high level. Literacy, healthy living and good standard of living give a measure of the human development in a country.

*Human Development Index (HDI):* Measured by parameters (indicators) such as life span, literacy and standard of living. Countries are listed on the basis of HDI—India occupies a low position (128) below Sri Lanka and close to Pakistan and Bangladesh.

*Infant Mortality:* Number of infant deaths per 1000 persons. High infant mortality leads to low life expectancy. Infant mortality is an index of the poverty of a country.

*Kerala Model:* Low birth rate (25 per 1000) as against Indian average (33 per 1000) and high female literacy (60% as against Indian average 13%) are distinctive features of the Kerala Model. This Model shows the way to population stabilisation in India.

*Life Expectancy:* Average number of years that a new born baby is expected to survive. This is also known as life span.—for Japan, 79 years while for India, 60 years.

*Population Crash (Explosion):* When population size exceeds the carrying capacity, it leads to population crash or explosion. India touched 1-billion mark population in May, 2000 and has shown fast population growth +2.4 per cent per decade since 1970, adding 18 million population (that of Australia) every year. At this growth rate, India will overtake China by 2025 and become the most populous country of the world. India suffers from population crash or explosion.

*Population Density:* Number of people per sq. km. of an area. Australia has low population density (4 people per sq. km.) while Bangladesh has high population density (1800 people per sq. km.).

*Population stabilisation:* Population kept at controlled rate preferably below 0.5 per cent as in the developed countries. Population stabilisation is the key to the economic development and resource management of a country.

## QUESTIONS

1. Trace the world population growth up to 2000 AD.
2. What is population explosion? How does it affect the economy of a country like India?

3. What is doubling time of population? Explain with reference to world population and Indian population.
4. How is infant mortality related to life expectancy?
5. Write notes on:
  - (a) Carrying capacity of the Earth.
  - (b) Population stabilisation and sustainable development.
  - (c) Human Development Index.



---

# Land and Water Resources of the Earth

## 5.1 LAND, WATER AND AIR— INTERRELATIONSHIP IN ECOSYSTEM

Land, water and air are the three important environmental segments which are in dynamic equilibrium with the biosphere and have constant interactions. The natural cycles (hydrological, carbon, oxygen, nitrogen, phosphorus and sulphur cycles) operate in this ecosystem whereby elements are continuously circulated for sustenance of life. The dynamic balance in the ecosystem is upset by human activities resulting in pollution which spoils the quality of the environment.

## 5.2 LAND RESOURCE AND LAND USES

Land is one of the most important components of life support system which has been exploited and abused over centuries. Our ancestors regarded land as the Mother Earth which should be handled with care and respect. In fact, ancient kings used to be called as “Bhoomipal”, i.e. custodian of land.

In a predominantly agricultural country like India, land is the top priority. Good soil forms the basis of good farming

and good living. An understanding of soil is the key to good farming.

Due to exploding population, more and more agricultural land is being sacrificed for housing. This poses threat to food production. Careless use of soil can damage soil which results in loss of soil quality and quantity of grassland and cropland. This is associated with soil erosion and degradation of water sheds and catchments, deforestation, desertification, etc. The recent Ethiopian experience of mass starvation and deaths due to acute famine should be a lesson for India. It must be remembered by all that land is a finite source with finite carrying capacity and only by integrated land use planning we can be saved from disaster. There is need of a National Policy on land/soil with short and long range objectives.

As indicated above, the land is subjected to demographic (population) pressures due to demands of agriculture, industries and urbanisation including construction of railways, highways, etc. Another important aspect is that cropland is fast losing fertile top soil (25 billion tons each year world-wise and 5 billion tons in India). This puts limitation on long-term crop production.

### **5.2.1 Land Use Planning**

Land use planning is in essence the determination of optimum use of every hectare of land of the country. Utilisation of land is important for satisfying the needs of people. Primary use of land is for agriculture in developing countries where farming is the occupation of majority of people. In the developed and also in developing countries other occupations based on land are industries, mining, commerce, etc. The roadways and railways also demand considerable land. In recent years pressure on land has increased due to demand for communication and this has in turn led to degradation of land.

Industrial uses of land have led to the growth of towns and hence urbanisation. Even in ancient time riverine civilizations flourished e.g. Indus, Egyptian, Babylonian, etc.



India has one of the lowest man:land ratio—hardly 0.48 ha. per capita. It has continuously decreased since the sixties. As we have limited land, we must take urgent measures for land-use planning in an integrated manner.

1. The concerned departments—Agriculture, Forest and Revenue should in a co-ordinated manner prepare soil maps of the country.
2. At the district or the village level, a nation-wide survey of land-use planning should be undertaken. This would enable to allocate land for short-term and long-term requirements for agriculture, forestry, vegetation, grassland, fisheries, water bodies, water sheds and water resources, human settlements, roads, transport, industries, mining, ports, harbour, etc. The planning process should take into account the requirements in relation to population explosion.

A scientific land-use planning is urgently needed in our country where 76 per cent people live in villages, over 40 per cent live below poverty line and about 50 per cent people are illiterate. The well-being of this vast poor population (400 million) depends directly on the land base which sustains them.

### 5.2.2 Watershed Management

Water is an integral part of land/soil productivity—its use and misuse can cause both soil degradation and soil erosion. Availability of water in a given soil environment is a critical factor and is related to erosion, siltation, loss of plant cover and productivity. Both control measures and production from land imply management of rainfall and resultant run-off. Such management can best be based on a natural unit called *watershed*. Watershed is an area bounded by the divide line of water flow so that a distinct drainage basin of a small or big water course of stream can be identified.

The Himalayas are one of the most critical watersheds in the world. The Gangetic basin has high population density—more

than 400 million people live in this basin. In the plains of Pakistan, India and Bangladesh more than 460 million people are affected by environmentally unsound developmental projects and land abuses in the mountains by about 46 million people in the Himalayan watershed. There is need for massive afforestation in these hill areas, particularly hilly slopes to make up for the damage already done by deforestation. It is also necessary to safeguard against environment damage caused by developmental projects in the region. With availability of less and less of snow in the Gangetic source, the Ganga will have less quantum of water flow and may dry up in future in the extreme case. That will lead to massacre of the Gangetic basin containing 40 per cent population.

### **5.2.3 Grazing Land**

India, with 1/40th of land area of the world, supports more than 50 per cent of world's buffaloes, 15 per cent of its cattle, 15 per cent of its goats and 4 per cent of its sheep. This livestock wealth plays a crucial role in rural life—it is a major source of fuel and draught power, of nutrition and of raw materials for rural industries. Indian farmers, as a matter of fact, practise a highly interdependent and independent system of agriculture and animal husbandry.

But this huge livestock population (460 million) needs fodder and there is not enough of it to meet their needs. Only about 13 million hectares are permanent grazing lands which are not enough—they exist in highly degraded state. The livestock are compelled to move to fallow land and uncultivable wasteland and finally to forests in search of fodder. One of the reasons for overgrazing is too many animals and too little grass.

Due to acute shortage of green fodder the animals mainly get crop residues such as rice straw and wheat straw as their food. While India devotes only 5 per cent of its cultivable land to fodder productions, developed countries like USA use 60 per cent of its cultivated land for this purpose.

Like human population, livestock population has to be reduced in order to prevent overgrazing. The potential of grazing lands in arid and semi-arid areas, e.g. vast areas in Rajasthan should be tapped for fodder production under social forestry programmes.

#### **5.2.4 Wastelands**

These are barren and uncultivable lands, affected by erosion, water logging, including degraded forest and non-forest lands. There are about 100 million hectares—one-third of India's land area is suffering from environmental problems. There are about 13 million hectares of wind-eroded land in Rajasthan (western district), Gujrat and Haryana.

#### **5.2.5 Mines**

Since independence India has seen rapid growth in mineral production to provide raw materials for industrial development. Fossil fuels comprise the bulk of the mining output—coal production tops the list. Iron ore, limestone and bauxite predominate among metallic and non-metallic minerals respectively.

Mining has adverse effect on the environment—it damages land, forests, water and air. The loss or pollution of natural resources degrades the quality of human life in these areas.

Much agricultural land is lost due to mining. Every mining enterprise means the conversion of land to such purposes as roads, railways and ropeways for mineral transport, housing for miners and staff, land for stockyard, etc. The disposal of mining wastes requires additional area and makes the surrounding land infertile. Much of the mining activity is being carried out in forested regions. The obvious result is deforestation and erosion. Mining wastes pollute streams and rivers. Mineral dust is a source of air pollution causing health hazards in an around mining areas.

While mineral production has increased about 50 times in the last 30 years, several million hectares of good crop and

forest lands have been destroyed by mining operations and hundreds of villages depopulated. The worst affected are tribals. More than 50 per cent of the national mining output comes from 40 contiguous districts of central and eastern India, the tribal heartland of the country.

### 5.3 WATER RESOURCES AND WATER USES

Man is using petroleum for more than a century extensively and coal for several centuries. Human civilisation spent 99.9 per cent of time without these fuels. The world's petroleum stock is likely to be exhausted in another hundred years and coal in a few centuries. This will pose a crisis before mankind. But when we realise that our usable water resources is also limited and will be out of stock in near future, then we indeed have cause for panic.

Water has no alternative—it is known as “life”. It is essential for the sustenance of all living organisms including plants, animals and man. All plants, insects, animals and men have 60–95 per cent water in their bodies. This water is partly released in the form of sweat, excreta, urine and vapour. So all these species require lot of water daily. Besides much water is also needed for body growth, nutrition, etc. So it is absurd to think of life without water. But our usable water resources like any other natural resource is finite and is likely to be exhausted within a century. Moreover, it is getting polluted by man-made activities and unfit for use sooner than expected. Water crisis is more serious than food or population crisis since food production or population problems are irrelevant without water supply. Use of polluted water itself takes toll of 25,000 people all over the world every day. In India out of 6 lakh villages, one third or about 2 lakh villages are without access to water. In these villages women have to walk daily about 1–14 km. to collect water for cooking and drinking. The United Nations Food and Agriculture department estimate that if the present day practices of wasting and polluting water are not stopped,

then within less than a century the world's biosphere including man will disappear.

The world's total quantum of water is 1.4 billion cubic kilometre. If all the sea beds could be filled up and brought at the level of the earth's surface, then the entire water in the seas would cover the earth's surface and make it 2.5 km.—deep water mass. About 97 per cent of earth's water supply is in the ocean which is unfit for human consumption and other uses due to high salt content. Of the remaining 3 per cent, 2.3 per cent is locked in the polar ice caps and hence out of bounds. The balance 0.7 per cent is available as fresh water but the bulk of it, 0.66 per cent, is ground water and the rest 0.03 per cent is available to us as fresh water in rivers, lakes and streams. The break-up of this 0.03 per cent fresh water is—lakes and ponds 0.01 per cent, water vapour 0.001 per cent, rivers 0.0003 per cent and water confined in plants, animals and chemicals 0.0187 per cent.

*[United National Water Conference Report, Argentina (1977)]*

Thus we see that we have a very limited stock of usable water, 0.03 per cent surface water (rivers, streams and ponds) and 0.66 per cent ground water. The quantity of water vapour arising from evaporation of sea water and river water returns by the same volume to the earth's surface by rainfall and back to the water sources. The hydrological cycle in nature is more or less balanced in terms of charge (cloud formation) and discharge (rainfall). But we are drawing large quantities of ground water for agriculture and industries while the waste water from these is much polluted and on mixing with rivers is polluting the rivers also.

The mass balance of annual rainfall shows that about 70 per cent is lost by evaporation and transpiration by plants, while the remaining 30 per cent goes into the stream flow. The approximate break-up of this stream flow, as consumed by man is—8 per cent for irrigation, 2 per cent for domestic use, 4 per cent for industries and 12 per cent for electrical utilities. Irrigation for agriculture and electric power plants are the major consumers of water.

### 5.3.1 Chemical Characteristics of Water

Sea water is unfit for our consumption due to high mineral salt content. Chemically speaking, sea water is a solution of 0.05 molar NaCl (Sodium chloride), 0.05 molar  $MgSO_4$  (Magnesium sulphate) containing traces of all conceivable matter in the universe. The oceans are the final sink for many substances involved in numerous geochemical processes as well as the waste dumped as a result of human activities. They receive the run-off of the continents and materials washed from the atmosphere. They are also the important habitat of the bulk of the earth's biosphere (sea plants, sea fish, etc.). The chemical composition of sea water, river and lake water is shown:

*Sea water:* Sodium, chloride, magnesium 90 per cent, Potassium, calcium, sulphate 3 per cent, others 7 per cent.

*River and Lake water:* Carbonate 35 per cent, sulphate 12 per cent, chloride 5.7 per cent, silica 11.7 per cent, nitrate 0.9 per cent; Calcium 20 per cent, sodium 5.8 per cent, magnesium 3 per cent, potassium 2 per cent, iron, aluminium oxide 3 per cent.

Ground water (wells, tube wells) contains more mineral salts, nitrate and bicarbonate than surface water (river, lake water, etc.)

## 5.4 WATER POLLUTION

The normal uses of water for public supply are—recreation (swimming, boating, etc.), fish, other aquatic life and wild life, agriculture (irrigation), industry, navigation, etc. Any change in the dynamic equilibrium in aquatic ecosystem (water body/biosphere/atmosphere) disturbs the normal function and properties of pure water and gives rise to the phenomenon of water pollution. The symptoms of water pollution of any water body/ground water are:

- Bad taste of drinking water,

- Offensive smells from lakes, rivers and ocean beaches,
- Unchecked growth of aquatic weeds in water bodies (eutrophication),
- Dead fish floating on water surface in river, lake, etc.
- Oil and grease floating on water surface.

The quality of water is of vital concern for mankind since it is directly linked with human welfare. It is a historical fact that faecal (human excreta or stool) pollution of drinking water caused water-borne diseases which wiped out entire populations of cities. In the developing countries like India, every day some 25,000 people die of water-borne diseases, e.g. jaundice, hepatitis, cholera, dysentery, etc. In India about 2 lakhs out of 6 lakh villages have no access to safe drinking water—women have to walk 1–14 km. daily for collecting water for drinking and cooking. In urban areas 40 per cent people are without access to safe water. The major sources of water pollution are domestic sewage from urban and rural areas, agricultural run-off (wash water) and industrial waste which are directly or indirectly discharged into water bodies.

#### **5.4.1 Water Pollutants**

The large number of water pollutants are broadly classified under the categories:

1. Organic pollutants,
2. Inorganic pollutants,
3. Sediments,
4. Radioactive materials, and
5. Thermal pollutants.

##### ***Organic Pollutants***

These include domestic sewage, pesticides, synthetic organic compounds, plant nutrients (from agricultural run-off), oil, wastes from food processing plants, paper mills and tanneries,

etc. These reduce dissolved oxygen (D.O.) in water. Dissolved oxygen (D.O.) is essential for aquatic life, the optimum level being 4–6 ppm (parts per million). Decrease in D.O. value is an indicator of water pollution. The organic pollutants consume D.O. through the action of bacteria present in water.

Sewage and agricultural run-off provide plant nutrients in water giving rise to the biological process known as *eutrophication*. Large input of fertiliser and nutrients from these sources leads to enormous growth of aquatic weeds which gradually cover the entire waterbody (*algal bloom*). This disturbs the normal uses of water as the water body loses its D.O. and ends up in a deep pool of water where fish cannot survive.

The production of synthetic organic chemicals (more than 60 million tons each year since 1980) multiplied more than 10 times since 1950. These include fuels, plastic fibres, solvents, detergents, paints, food additive, pharmaceuticals, etc. Their presence in water gives objectionable and offensive tastes, odour and colours to fish and aquatic plants.

Oil pollution of the seas has increased over the years, due to increased traffic of oil tankers in the seas causing oil spill and also due to oil losses during off-shore drilling. Oil pollution reduces light transmission through surface water and hence reduces photosynthesis by marine plants, decreases D.O. in water causing damage to marine life (plants, fish, etc.) and also contaminates sea food which enters the human food chain.

Pesticides have been largely used for killing pests and insects harmful for crops and thereby boosting the crop production. At present there are more than 10,000 different pesticides in use. They include insecticides (for killing insects), e.g. DDT (dichloro diphenyl trichloroethane), herbicides (for killing weeds and undesirable vegetation) and fungicides (for killing fungi and checking plant disease).

It has been found that pesticide residues contaminate crops and then enter the food chain of birds, mammals and human beings. The persistent pesticide, viz., DDT (which is not degraded



in the environment) accumulates in food chain, getting magnified in each step from sea weed to fish and then to man by about ten thousand times ( $10^4$ ). Thus the average level of DDT in human tissues is found to be 5–10 ppm, maximum being among Indians (25 ppm) compared to Americans (8 ppm).

### *Inorganic Pollutants*

This group consists of inorganic salts, mineral acids, metals, trace elements, detergents, etc.

*Acid mine drainage:* Coal mines, particularly those which have been abandoned, discharge acid (sulphuric acid) and also ferric hydroxide into local streams through seepage. The acid on entering the waterbody destroys its aquatic life (plants, fish, etc.).

### *Sediments*

Soil erosion, as a matter of natural process, generates sediments in water. Solid loadings in natural water are about 700 times as large as the solid loading from sewage discharge. Soil erosion is enhanced 5–10 times due to agricultural and 100 times due to construction activities. Bottom sediments in aquatic bodies (streams, lakes, estuaries, oceans) are important reservoirs of inorganic and organic matter, particularly trace metals, e.g. chromium, copper, nickel, manganese and molybdenum.

### *Radioactive Materials*

Radioactive pollution is caused by mining and processing of radioactive ores to produce radioactive substances, use of radioactive materials in nuclear power plants, use of radioactive isotopes in medical, industrial and research institutes and nuclear tests. The discharge of radioactive wastes into water and sewer systems is likely to create problems in future.

### *Thermal Pollutants*

Coal-fired or nuclear fuel-fired thermal power plants are sources of *thermal pollution*. The hot water from these plants is dumped as waste into nearby lake or river where its temperature rises by about 10° C. This has harmful effect on aquatic life in the water body whose D.O. is reduced and as a result, fish kill is quite common.

#### **5.4.2 Ground Water Pollution/ Arsenic Contamination**

Ground water is relatively free from surface contamination as it is located more than about 50 ft. below the land surface and the surface water gets filtered or screened by the underlying layers of soil, sand and stone pieces. But even then it gets contaminated due to leaching of minerals below the earth's surface.

An important case is that of *Arsenic (As)–contamination of ground water*. This arises from excessive pumping of ground water by shallow tube wells for irrigation in some West Bengal districts along the Hooghly river course and also in Bangladesh along the Padma river course. In this process air (oxygen) is injected into ground water bed which leaches the overlying mineral, iron pyrites (iron, arsenic, sulphide), oxidises it and releases arsenic into ground water.

More than one million people in six districts of West Bengal drink arsenic-contaminated ground water from tube wells in the region. Among them 20 lakh people suffer from various diseases related to arsenic poisoning like loss of hair, brittle nails, bronchitis, gangrene, etc. Several hundred deaths have also been reported. Similar calamity has threatened the lives of Bangladesh in the districts along the Padma river course.

#### **5.4.3 Case Study of Ganga Pollution**

The most typical example of river pollution is the *Ganga Pollution*.

The Ganga originates from the Himalayan glacier and flows along a stretch of some 2525 km. before joining the Bay of Bengal. The Ganga basin is fertile and home of about 40 per cent of population (400 million people) of the country. The river has been hailed as the “Holy Ganga” and regarded as the lifeline of the country. But in recent years it is ranked as the most polluted river of India and a killer in the highly polluted areas.

The Ganga basin carries wash water from 25 per cent of land. It is responsible for agricultural prosperity of U.P, M.P, Haryana, Rajasthan, Himachal Pradesh, Bihar and West Bengal. Ganga is the source of drinking water in the region and irrigation water for agriculture—she also supplies fish to the local markets and water to industries on both sides of the river. The Ganga basin provides maximum population density—many class I (population 100,000 and above), class II (pop. between 50,000 and less than 100,000) and class III (pop. 20,000 to less than 50,000) cities have grown in this region. Both domestic and industrial sewage join the Ganga river without any treatment and thus cause terrible pollution.

Hooghly river (in West Bengal) near Calcutta presents the worst polluted zone. There are more than 150 industries on both sides of the 125 km.—stretch river belt—there are about 270 outlets of untreated sewage to the river Hooghly. The entire 140 sq. km. metropolitan area covering both banks of the Hooghly river is exposed to ecological disaster. Besides huge quantities of soil from soil erosion due to extensive deforestation are washed by rain water into the river causing siltation. This reduces the flow of water in the Bhagirathi-Hooghly river with the result that ultimately the river will be choked and dead. In 1919 the flow of water in the Ganga was 1,10,000 cusecs (1 cusec = 1 cubic foot of water flowing per second) whereas in 1971 it was 40,000 cusecs only which during summer drops to 20,000 cusecs. This should be enough to sound the alarm bell to the Government—Calcutta and Haldia ports can survive only on 40,000 cusecs of water.

### 5.5 WASTE WATER TREATMENT

Water pollution is caused by domestic sewage (84 per cent) and industrial sewage (16 per cent). Though the latter has less load on water body, it contains toxic matter (inorganic and organic) which are more hazardous.

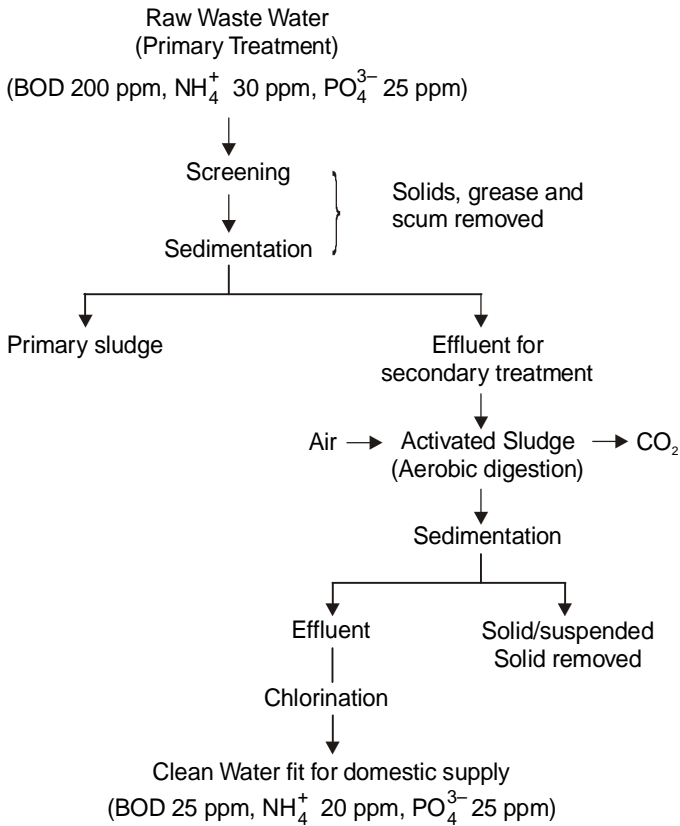

BOD = Biological Oxygen Demand (Index for organic matter content)  
 1 ppm = 1 part per million, i.e. 1 in  $10^6$  parts

**Fig. 5.1** Municipal waste water treatment (primary and secondary)



These waste liquids (effluents) can be purified by filtration using activated charcoal or ion exchange resins. Activated charcoal has large surface area and is an effective filter medium for adsorption of organic molecules. Synthetic organic ion exchange resins are very useful for removal of industrial waste metals (cations) and non-metals (anions).

## 5.6 WATER QUALITY

It is essential to enforce water quality standards in the interest of public health. All developed countries strictly conform to water quality standards. Polluted water generates water-borne diseases which kill millions of people every year all over the world, particularly in developing countries. The United States Public Health (USPH) has laid down standards for water quality parameters (indicators) for drinking water. These are the upper limits in parts per million (ppm) (1 ppm = 1 in  $10^6$  parts).

**Table 5.1** Water Quality Parameters (Domestic Water Supplies) USPH Standards (Upper Limits)

<i>Parameters</i>	<i>(in ppm, except for pH)</i>
pH	6.0–8.5
Dissolved oxygen (D.O.)	4.0–6.0 ppm
Total dissolved solid	500.0
Suspended solid	5.0
Chloride	250.0
Sulphate	250.0
Cyanide	0.05
Nitrate + Nitrite	10.0
Ammonia	0.5
Calcium	100.0
Magnesium	30.0
Iron	0.3
Lead	0.05

*(Contd)*

---

<i>Parameters</i>	<i>(in ppm, except for pH)</i>
Mercury	0.002
Arsenic	0.05
Chromium (VI)	0.05
Zinc	5.5
Phenol	0.001
Chemical Oxygen Demand (COD)	4.0

---

All parameters except pH are in ppm.

1 ppm = 1 in  $10^6$  parts

The parameters for surface water (rivers, lakes, etc.) are 4–5 times higher than the above values for drinking water.

## 5.7 WATER POLLUTION CONTROL AND WATER MANAGEMENT—WATER RECYCLING

Clean water is essential for healthy environment to support life systems on this planet. The task of delicately balancing the ratio of available and exploitable water resources and sustaining their quality is most important for India as rainfall distribution is confined to 3–4 months in a year. Moreover, man-made global and local climatic distortions due to global warming (*see* Chapter 6), deforestation, loss of top soil, etc. have adverse effect on the monsoon pattern in India.

India is blessed with good rainfall (average 200 cm in a year) but 70 per cent of it is wasted. The country faces recurring problems of floods, and droughts and highly polluted water resources. It is necessary to do rain harvesting, i.e. build large tanks and reservoirs all over the country to store rain water, flood water and excess water from the Ganga, Brahmaputra and other rivers. The rivers, the lifelines of our culture and economy, are dying because of severe pollution. This water pollution abatement and resource management should be at the top of our national agenda.

The river water pollution has three dimensions—agricultural run-off, industrial effluents and domestic sewage. A typical example is that of the Ganga pollution. The total quantity of fresh water used in the Ganga basin is 150 billion cubic meters out of which 26 per cent is discharged as waste water. Agricultural run-off is 27 billion cubic metre compared to 1530 million cubic metre from industrial and domestic sewage.

### 5.7.1 Ganga Action Plan

This best illustrates the strategy of water pollution control and management. In order to rejuvenate (i.e. bring back to life) Ganga, the first step is to stop dumping of all sorts of garbage to the river and at the same time to promote public awareness on the issue. The sources of such garbage are domestic sewage, industrial sewage and agricultural run-off. Every day about 1200 million litres of waste water (mainly from West Bengal) enter the Ganga.

Industrial sewage has to be treated at the plant site through treatment plants and then the treated effluent discharged into the river or recycled for reuse. Domestic sewage in rural and urban areas should be diverted into separate diversion canals and collected in lagoons, subjected to treatment plants and the resulting clean water used for irrigation in agricultural fields. The biogas (methane,  $\text{CH}_4$ ) emitted from the treatment plants can be used for domestic fuel in industrial areas.

With this objective, the Government of India launched Ganga Action Plan in 1986 and entrusted the job to the State Governments concerned (UP, Bihar and West Bengal) for implementation. The Action Plan has the following agenda:

- (i) To divert sewage from the small and large towns on both embankments of the Ganga into separate diversion canal, accumulate it in big lagoons, subject it to sewage treatment plant and use the clean sewage water for agriculture. The emitted biogas (methane,  $\text{CH}_4$ )



from the plant is utilised as domestic fuel through piped gas supply in adjoining towns.

- (ii) To construct low cost sanitary latrines (about 30,000) so that people don't commit nuisance on the river embankments.
- (iii) To construct the Ganga embankment ghats and construct electric furnaces at selected sites for funeral rites so that the Ganga is saved from dead bodies.
- (iv) To make it mandatory for all industries to install treatment plants in their premises for treatment of their solid and liquid effluent as well as gaseous emission.

For the success of the Ganga Actions Plan, it is essential that the public must be involved—at least they must be made aware of the critical condition of Ganga and need for recovery. For this purpose public awareness campaign deserves top priority. It must be noted that Ganga has three major problems—pollution, erosion and siltation. 70 per cent of pollution is generated from towns (class I 27, class II 23 and class II 48) on both sides of the river, 20 per cent from factories and 10 per cent from agricultural lands. The Ganga Action Plan, however, could not be properly implemented. It required active government—people interaction and participation and furthermore, continuous monitoring of the Projects by experts on a long-term basis. The Ganga Action Plan should be executed as a matter of 20 year plan instead of one or two 5 year plans only.

### **5.7.2 Desalination**

Only 0.69 per cent of total water resource is available as fresh water for our consumption. But this resource is shrinking due to reckless water pollution so that in future we may lose it. In that case we have to turn to the vast resource, i.e. sea water (97 per cent), which, at present, is unfit for our consumption due to high salt content. It is possible to utilise sea water with

appropriate technology after removal of salts and thus solve water crisis. The technology of removing salts from sea water is known as *desalination*. Israel and Arab countries have started applying this technology for solving their chronic problem of water scarcity.

There are several methods for desalinisation of sea water. The most economical method is to use solar energy for evaporation of sea water and separation of salts. For this purpose metal tanks with low height are used for collecting water. The tanks are painted black on the outside walls so that they become hot in the sun while the tanks are covered inside on the top with transparent plastic sheets. The water vapour from evaporation of sea water by the sun collects on the inside wall of the plastic sheet—on condensation, this water vapour gives pure water. At the end of the operation, salts are recovered from the tanks. Recently Israel is getting each year 30 million cubic metres of salt-free sea water.

*Electrodialysis* and *Membrane Technology* are being used in Japan to obtain salt-free sea water and salts separately. Though these techniques are costly, at present, but with enhanced technology, it may be possible in future to run these on commercial basis.

### **Key Terms and Concepts (Glossary)**

*Arsenic Contamination (Pollution)*: Ground water in some West Bengal and Bangladesh districts along the Hooghly/Padma river courses has been found to be contaminated with arsenic. This has been explained to be due to heavy withdrawal of ground water by shallow tube wells for irrigation in these districts. Arsenic is leached from the overlying mineral (iron pyrites) and released into ground water. More than a million people in the region drink arsenic-contaminated drinking water and about 25 per cent are suffering from various diseases due to arsenic poisoning.

*Desalination:* The technology of removing salts from sea water is known as desalinisation. Solar energy is utilised for evaporation of sea water and separation of salts. Sea water, after desalinisation, will provide an unlimited supply of water for domestic and other uses. This will solve the present and future water crisis.

*Ganga Action Plan:* A master plan to clean up the Ganga was launched by the Government of India in 1986. The job was entrusted to the State Governments concerned viz. U.P., Bihar and West Bengal. The Action Plan includes diversion of sewage, meeting the river, into separate lagoons for sewage treatment, construction of sanitary latrines near the river embankments, treatment of industrial wastes in the respective plant sites and public awareness campaign. Although some progress has been made, there is lot more work to be done for protection of the river.

*Ganga Pollution:* Ganga is regarded as the lifeline of the country, flowing from the Himalayan glacier along a course of 2525 km. and joining the Bay of Bengal. The river is regarded as the “Holy Ganga” but recently ranked as the most polluted river in India. The Ganga basin has the maximum population density. The Ganga pollution is due to domestic and industrial sewages joining the river as well as agricultural runoff (wash water from agricultural fields).

*Grazing Land:* Land where grass grows (pasture) which offers fodder for cattle, buffaloes, goats and sheep. India has a huge livestock population (about 450 million) which do not have enough fodder from grazing lands and are compelled to move to wasteland and forests in search of fodder. Thereby land gets degraded.

*Ground Water:* The water below the earth’s surface (50 ft. or more) is known as Ground Water, which is the major portion (0.66%) of fresh water. Irrigation for agriculture requires heavy withdrawal of ground water through shallow tube wells.

Ground water is relatively clean because of its location below the land surface where it gets filtered through layers of soil and rocks but it gets polluted due to leaching of minerals from above. (See Arsenic pollution).

*Land Use Planning:* Land, an important component of our life-support system, requires careful utilisation to satisfy the needs of the people. The uses of land include agriculture, forestry, housing, urbanisation, industrialisation, roadways, railways, etc. The welfare of a country depends on land use planning by the government.

*Wasteland:* Barren (unproductive) and uncultivable land due to soil erosion, waterlogging, etc.

*Waste Water Treatment:* Both domestic sewage (84%) and industrial sewage (16%) are responsible for water pollution. Municipal waste water is handled by sewage treatment plants. The processes are screening, sedimentation, biological decomposition, chlorination, etc. of effluent. The resulting clean water is fit for domestic use.

Industrial wastes are treated by activated charcoal filtration or ion exchange resins.

*Water Pollution:* Man-made activities disturb the biological and physico-chemical properties of water and lead to water pollution. The common sources of water pollution are sewage (pathogenic), chemical salts, organic matter, etc., industrial chemicals including fertilisers, pesticides, etc. which are directly or indirectly discharged into water bodies. Water pollution must be controlled to ensure good quality of water which is essential for the welfare of mankind.

*Water Pollutants:* Consist of organic pollutants (domestic sewage, pesticides, synthetic organic compounds, etc.), sediments, radioactive materials, inorganic pollutants, (inorganic salts, acids, metals, etc.).

*Water Quality:* The extent of purity of water for drinking, domestic and other purposes is called the water quality. Good water quality is essential for sound public health. The World Health Organization (WHO), US Public Health and Indian Standards Institution have laid down standards for water quality parameters.

*Water Recycling:* Polluted waste water, after treatment and purification, can be reused for domestic and industrial purposes and for irrigation.

*Water Resources:* Consist of seas and oceans (97%), polar ice caps (2.3%) and fresh water in rivers, lakes and streams and ground water (0.66%). Water is essential for the sustenance of all living organisms including plants, animals and man. The water resources are limited and are not likely to last for more than a century. Water pollution by man-made activities will lead to water famine and crisis in future.

*Watershed:* An area enclosed by a drainage basin of a small or big water course of a river or stream. The Himalayas are one of the critical watersheds in the world and Ganga basin is an important Himalayan watershed. Watershed management plays an important role in protection of environment of the region.

## QUESTIONS

1. What are the various uses of land?
2. Give an account of land use planning.
3. What is meant by “Water Shed”? Explain with reasons the importance of watershed management in our national policy.
4. What are the sources of fresh water? Give their quantities in terms of total percentages of water resources.
5. List the uses of water by man giving their relative percentages.

6. Compare the chemical composition of sea water with that of lake and river water.
7. What are the organic water pollutants? How do they cause water pollution?
8. Write notes on—(a) Eutrophication, and (b) Pesticide with reference to their ability to damage aquatic ecosystem.
9. Write an account of domestic waste water treatment.
10. Give a flowsheet diagram of municipal waste water treatment (primary and secondary).
11. List water quality parameters for drinking water (USPH standard) and give their permissible limits.
12. Describe briefly the Ganga pollution mentioning the pollution sites with their relative order of pollution.
13. Illustrate water pollution control and management with the example of Ganga Action Plan.
14. Write a note on desalination (desalination) of sea water.



---

# Air Resources

## 6.1 COMPOSITION

The atmosphere has, broadly speaking three major types of constituents—major, minor and trace. Pure (pollution-free) dry air at ground level has the components as follows, expressed in percentage by volume (within brackets):

Major components	Nitrogen (78.09) Oxygen (20.94) Water vapour (0. 1)
Minor components	Argon (0.9) Carbon dioxide (0.032)
Trace components	Neon (0.0018) Helium (0.0005) Methane (0.0002), etc.

The corresponding values in ppm (parts per million) are obtained by multiplying the above per cent volumes by  $10^4$ . Thus nitrogen ( $78.09 \times 10^4$  ppm). oxygen ( $20.94 \times 10^4$  ppm), carbon dioxide (325 ppm) and so on.

The properties (parameters) of the atmosphere vary much with altitude. The density shows a sharp decrease with increasing altitude. Pressure drops from 1 atmosphere at sea level to

$3 \times 10^{-7}$  atmosphere at 100 km. above sea level while temperature varies from  $-92^\circ$  to  $1200^\circ$  C. The total mass of the atmosphere is about  $5 \times 10^{15}$  tons which is roughly one millionth of the earth's total mass  $5 \times 10^{24}$  kg).

### 6.1.1 Structure

The atmosphere may be broadly divided into four regions as shown in the Table below. It extends up to 500 km. with temperature varying from a minimum of  $-2^\circ$  C to a maximum of  $1200^\circ$  C at 500 km. and above (*see* Table 6.1).

The Troposphere contains 70 per cent of the mass of the atmosphere. Density decreases exponentially with increasing altitude. The temperature decreases uniformly with increasing altitude. In this region air masses are constantly in circulation as there is global energy flow arising from the imbalances in heating and cooling rates between the equator and the poles.

**Table 6.1** Major Regions of the Atmosphere

<i>Region</i>	<i>Altitude range, km</i>	<i>Temperature range °C</i>	<i>Important chemical species</i>
Troposphere	0–11	15 to $-56$	Nitrogen, oxygen, carbon dioxide, water vapour
Stratosphere	11–50	$-56$ to $-2$	Ozone
Mesosphere	50–85	$-2$ to $-92$	Oxygen <sup>+</sup> , nitric oxide
Thermosphere	85–500	$-92$ to 1200	Oxygen <sup>+</sup> , Nitric oxide <sup>+</sup>

Oxygen<sup>+</sup> = oxygen molecule/atom with +ve charge.

Nitric oxide<sup>+</sup> means nitric oxide molecule with +ve charge.

These molecules or atoms pick up charge in the upper atmosphere.



In contrast to the troposphere, the stratosphere is the quiet layer having a positive lapse rate, i.e. increase in temperature with increase in altitude. Here ozone absorbs ultraviolet radiation and raises the temperature. This ozone layer plays a very important role in the stratosphere. It serves as a protective shield for life on earth from the harmful effects of the sun's ultra-violet radiation. Because of slow mixing in the stratosphere, the molecules or particles in the region stay for a long time. If some pollutants enter this layer, they will stay for a long period and slowly descend to the troposphere causing long-term global hazards. Introduction of nitrogen oxides by jet planes and refrigerant gases (Chlorofluorocarbon) leads to thinning of ozone layer and generates Ozone Hole (*see* Section 6.3).

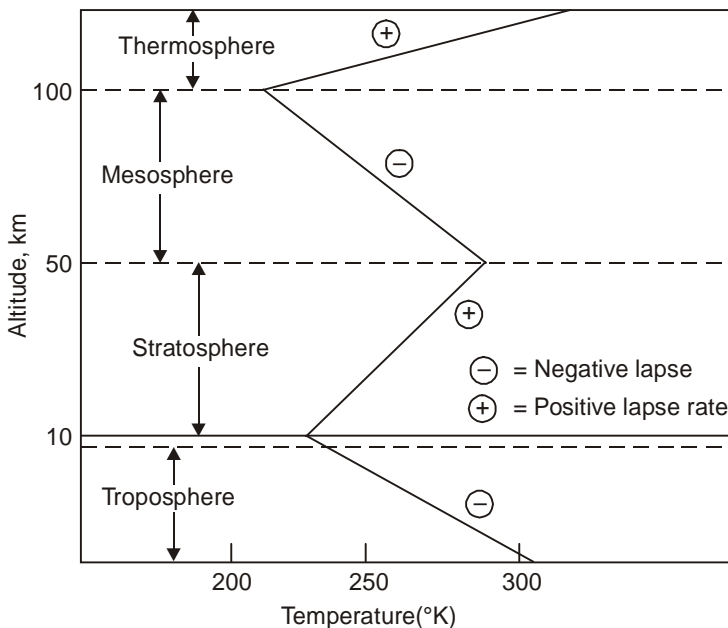

**Fig. 6.1** Major regions of the atmosphere with temperature profile

$1^{\circ} \text{ K} = -273^{\circ} \text{ C}$ ; (-) = Negative lapse rate, i.e. temperature decreases with increase in altitude; (+) = Positive lapse rate, i.e. temperature rises with increase in altitude.

In the mesosphere, there is temperature drop with increasing altitude. This is due to low levels of ultra-violet species, viz. ozone. In the thermosphere the temperature rises once again giving a positive lapse rate. Here oxygen and nitric oxide ionize after absorption of solar radiation in the far ultra-violet region.

## 6.2 GREENHOUSE EFFECT (GLOBAL WARMING)

Carbon dioxide is a non-pollutant gas in the atmosphere and a minor constituent (356 parts per million) but it is of serious concern for the environment for its ability to change the global climate.

The earth's surface partly absorbs sun's rays while emits long-wave infra-red radiation (8000-25000 nanometres; 1 nanometre =  $10^{-9}$  metre = 1 nm). Carbon dioxide and water vapour in the atmosphere strongly absorb infra-red radiation (14,000–25,000 nm) and effectively block a large fraction of the earth's emitted radiation. The radiation thus absorbed by carbon dioxide and water vapour is partly returned to the earth's surface. The net result is that the earth's surface gets heated and the phenomenon is known as the *Greenhouse Effect* (Fig. 6.2).

The carbon dioxide level in air has increased from 280 ppm (pre-Industrial revolution era 1780) to 350 ppm at present in two centuries. Fossil fuel (petrol, diesel, coal) combustion is the major source of increase of carbon dioxide level increasing at the rate of 1–2 per cent per year. At this rate of increase, the earth's surface temperature may rise as much as 2° C in the next 100 years. However, nature has its check and balance system. The rate of increase of carbon dioxide is only 50 per cent of its expected magnitude due to the sinks, viz. oceans and photosynthesis by green plants (Fig. 6.3).

It may be noted that a slight rise in temperature even by 1° C, can have adverse effect on the world food production.

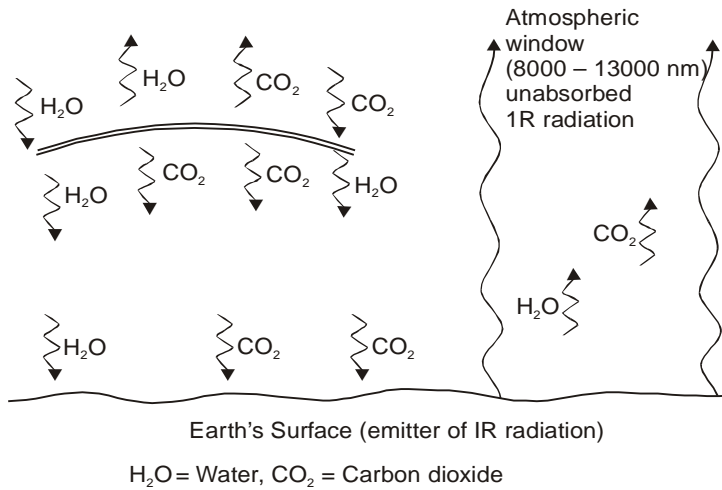

Fig. 6.2 The greenhouse effect

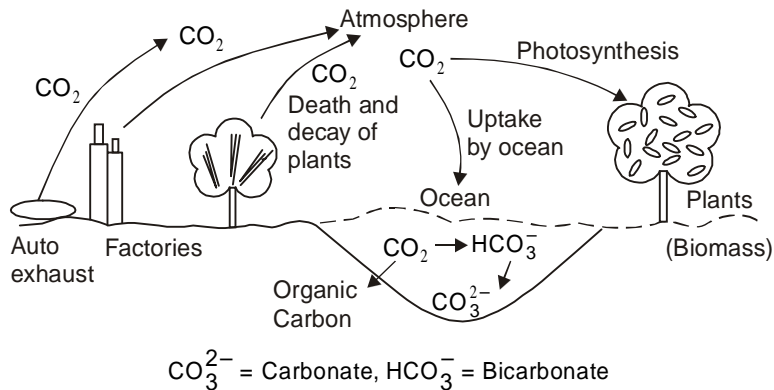

Fig. 6.3 Sources and sinks of carbon dioxide

1. Thus wheat producing zones in the northern latitude will be shifted from CIS (former USSR) and Canada to the north pole and in India from UP, Panjab, Haryana to the Himalayas, i.e. from fertile to non-productive soil. In other words, wheat production will badly suffer.

2. The biological productivity of the ocean will fall due to warming of the surface layer. This reduces transport of nutrient from deeper layers of the ocean to the surface by vertical circulation. Moreover, there will be less photosynthesis by marine plants. In other words, the production of sea food (marine plants and fish) will decline. Sea food constitutes more than 30 per cent of our food supply.
3. Another disastrous effect is the rise in sea levels by as much as 15 cm in the next 100 years due to partial melting of polar ice caps. This sea level rise would threaten coastal cities (Calcutta, Mumbai, Chennai, etc.) and some 60-odd island nations such as Maldives, Bangladesh, etc. which will be drowned under the sea. When Himalayan snow melts and gets exhausted, the Himalayan rivers including Ganga may dry up—the Ganga valley will be hot and north India will lose its population base. At the same time India will lose its major life line, Ganga.

### 6.2.1 Other Greenhouse Gases

Carbon dioxide is not the only culprit responsible for Greenhouse Effect and global warming. Other greenhouse gases are: methane, chlorofluorocarbons, nitrous oxide, ozone and water vapour. The relative contributions of these gases to greenhouse effect are:

- Carbon dioxide 50 per cent; Methane 19 per cent; Chlorofluorocarbons 17 per cent; ozone 8 per cent; nitrous oxide 4 per cent; water vapour 2 per cent.

This shows that carbon dioxide accounts for 50 per cent of the greenhouse gases. The shares of methane (19 per cent) and chlorofluorocarbons (17 per cent) (gases from refrigerators and air-conditioners) cannot be ignored.

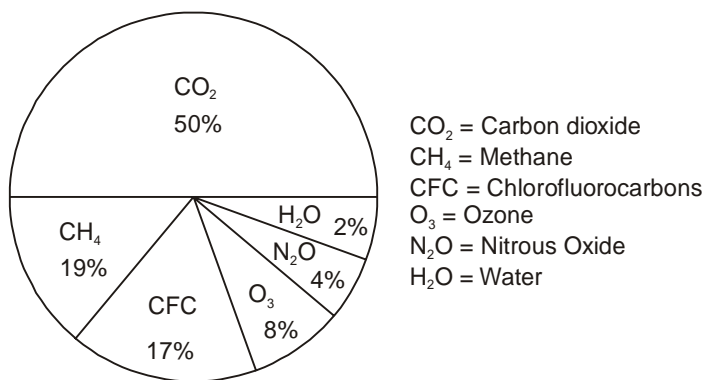
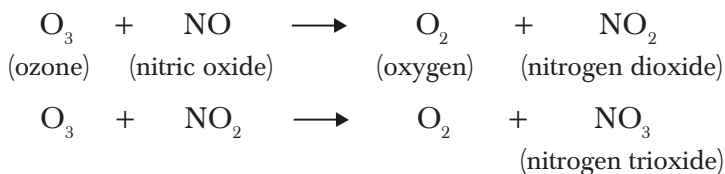

Fig. 6.4 Greenhouse gases (relative shares)

### 6.3 OZONE HOLE

In the stratosphere, the second region of the atmosphere, ozone is present in small quantities but it is protective shield for the earth. Ozone strongly absorbs ultraviolet radiation from the sun (295–320 nm) which is injurious for life on earth. Thus it protects living species on earth. But recent human activities have injected some dangerous chemicals in the stratosphere which consume ozone and reduce its concentration. This is the phenomenon of *ozone hole* in the stratosphere.

Exhaust gases from jet aircrafts and artificial satellites discharge nitric oxide (NO), nitrogen dioxide (NO<sub>2</sub>), etc. which immediately react with ozone.



Chlorofluorocarbons (CFC) are used as coolants in refrigerators and air-conditioners. These slowly pass from troposphere and stratosphere and once there, they stay for 100 years.

In presence of ultraviolet radiation (200 nm) from the sun, CFC breaks up into chlorine-free radical (Cl) which readily consumes ozone.

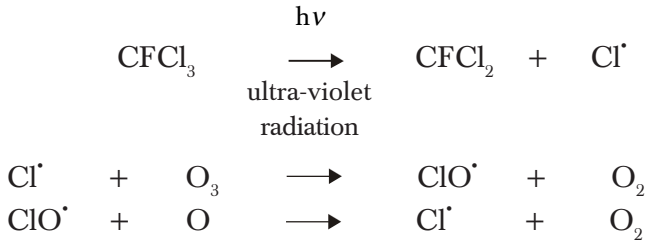

The free radical (Cl<sup>•</sup>) is regenerated and continues the chain reaction. It is estimated that one molecule of CFC consumes one lakh molecules of ozone. The damage by CFC continues for 100 years. Even if CFC production is stopped now all over the world, the CFC that is already there in the stratosphere will continue to damage the ozone layer for the next 100 years.

In 1979 ozone hole was observed in the sky over Antarctica—here ozone layer thickness was reduced by 30 per cent. Later on ozone hole was discovered in the sky over the thickly populated northern hemisphere. Here in winter ozone thickness was reduced by 4 per cent and in summer by 1 per cent.

Ozone hole allows passage of ultraviolet radiation to the earth where it causes skin cancer, eyesight defect, genetic disorder, etc. in the biosphere (man, animal and plant). In Europe and USA there is an increase in the cases of skin cancer among people while some million people are suffering from eye cataract.

In Montreal Conference (Montreal Protocol, 1987) and London Conference (1992) it was decided that the developed countries would totally ban CFC production by 2000 and the developing countries by 2010 AD. But as stated above, even after the ban is enforced, the CFC and Cl<sup>•</sup> shall continue their havoc for another 100 years. Researches are on for development of CFC-substitutes as coolants for refrigerators and air-conditioners.

The Kyoto Treaty (1997) for reducing greenhouse gas emissions by developed countries was signed by all these countries except USA.

#### 6.4 El NINO

Greenhouse effect, as discussed above, is an atmospheric warming phenomenon while El Nino is an ocean warming phenomenon. El Nino is a Spanish term for the Christ child as it starts in December in South American coast but it affects climate over half the globe.

Under normal conditions the water of the Eastern Pacific off Ecuador, Peru and Chile is cooler by  $10^{\circ}\text{C}$  than the waters of the Western Pacific. This promotes fisheries along the Eastern Pacific coast since cold waters, rich in nutrients, spring from the deep layers of the ocean. The trade winds blow along the equator from Southeast Pacific towards West pushing warm waters out to the ocean. But once every three to five years the trade winds reverse their direction, i.e. from west to east thereby pushing warm waters to the east. As a result, the Eastern Pacific water warms up by about  $4^{\circ}\text{C}$  ( $24^{\circ}$  to  $28^{\circ}\text{C}$ ) which disrupts the anchovy fishery, key to the Peruvian economy. This happens when El Nino appears. It not only kills fish but warms the air which lowers the atmospheric pressure and sparks storms and heavy rainfall along Chile coast and spreading up to Southern California (USA).

In 1982, El Nino raised sandstorms in Australia, cyclones in Tahiti, caused droughts in Africa and floods along the Californian coast in USA. Recently in 1998, El Nino activity has been felt all over the world. In the east coast of USA, winter was missing in January–February and in the west coast there was record rainfall in 100 years of US history. Research is on to understand the science of El Nino so that it can be forecast and advance warning signal sent to the regions where lives and properties can be saved in time.

## 6.5 AIR POLLUTION

Pure air is colourless and odourless. But various pollutants from natural and man-made sources are entering the atmosphere daily and these disturb the dynamic equilibrium in the atmosphere. This leads to air pollution when the normal properties of air are upset and both man and environment suffer.

Natural sources of air pollution are:

- Volcanic activity, vegetation decay, forest fires emitting carbon monoxide, sulphur dioxide and hydrogen sulphide and tiny particles of solids or liquids sprayed from the seas and land by wind.

Man-made sources are:

- Gases, mists, particulates and aerosols emitted by industries and other chemical and biological processes used by man.

### 6.5.1 Primary Pollutants

There are five primary pollutants which together contribute more than 90 per cent of global air pollution:

Carbon monoxide, CO  
Nitrogen oxides, NO<sub>x</sub>  
Hydrocarbons, HC  
Sulphur oxides, SO<sub>x</sub> and  
Particulates.

Transportation accounts for more than 46 per cent of the total pollutants produced per year and hence remains the principal source of air pollution. Carbon monoxide is the major industrial pollutant, with a tonnage matching that of all other pollutants together. However, particulate pollutants, though minor, are the most dangerous among the primary pollutants (100 times more harmful than carbon monoxide).



**Table 6.2** Primary Air Pollutant sources and Their Quantities (Million Tons per Year)

<i>Sources</i>	<i>Weight of pollutants produced*</i>				<i>Particulates</i>		<i>Total weight of pollutant produced</i>
	<i>CO</i>	<i>NO<sub>x</sub></i>	<i>HC</i>	<i>SO<sub>x</sub></i>	<i>&lt;20μ</i>	<i>&gt;30μ</i>	
	Transportation	70	10	10.8	0.8	1.2	
Fuel combustion (stationary sources)	1.2	11.8	1.4	21.9	4.6	1.3	42.2
Industrial processes	7.8	0.7	9.4	4.1	6.3	2.7	31.0
Solid waste disposal	7.8	0.8	1.6	0.1	1.1	—	11.2
Miscellaneous	8.5	0.4	6.3	0.1	1.3	—	16.6
Total weight of pollutant produced (in million tons)	95.0	23.6	29.5	27.0	—	19.5	194.6

1μ = 10<sup>-6</sup> metre (1 part in 1 million parts of 1 metre)

\*Chemical names—see p. 95

The above data are taken from those in USA (1990). As a matter of fact, USA and other developed countries contribute most to air pollution.

### 6.5.2 Carbon Monoxide, CO

It is a colourless, odourless and tasteless gas which is injurious to our health. Each year 350 million tons of CO (275 million tons from human sources and 75 million tons from natural sources) are emitted all over the world in which USA alone shares 100 million tons. Transportation accounts for 70 per cent of CO emission. That is to say, diesel and petroleum engines in automobiles are primarily responsible for about 70 per cent of CO emissions.

The sources of carbon monoxide, CO are the chemical reactions:

- (i) incomplete combustion of fuel or carbon containing compounds:

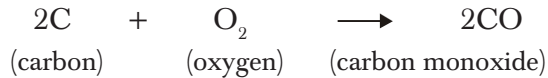

- (ii) reaction of carbon dioxide and carbon-containing materials at elevated temperatures in industries, e.g. in blast furnaces:

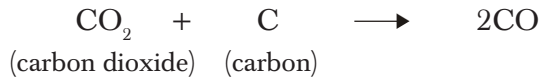

- (iii) dissociation of carbon dioxide at high temperatures:



### 6.5.3 Sinks

Part of Carbon monoxide is lost in the upper atmosphere. The major sink is soil micro-organisms. A potting soil sample weighing 28 kg can completely remove in 3 hours 120 ppm carbon monoxide from ambient air. The same soil sample on sterilization failed to remove carbon monoxide from air.

### 6.5.4 Control of CO Pollution

The petroleum and diesel-fed automobiles account for major share of carbon monoxide emission. Hence efforts for carbon monoxide pollution control are mainly aimed at automobiles. Use of catalytic converters in the internal combustion engines of automobiles helps in cleaning up the exhaust emissions. Such converters built into the automobile engines promote oxidation-reduction cycles and ensure complete combustion of carbon monoxide, nitrogen oxides and hydrocarbons. The following figure and flow-sheet illustrate the action of catalytic converters: Use of catalytic converters in two stages helps in elimination of pollutants from exhaust gases before they are discharged into the atmosphere.

In the first converter nitrogen oxides are reduced to nitrogen (+ ammonia) in presence of finely divided catalyst platinum, and the reducing gases, carbon monoxide and hydrocarbons. The production of ammonia is kept at a minimum under carefully controlled conditions. In the second converter, air is introduced to provide an oxidizing atmosphere for complete oxidation of carbon monoxide and hydrocarbon into carbon dioxide and water in presence of finely divided platinum catalyst.

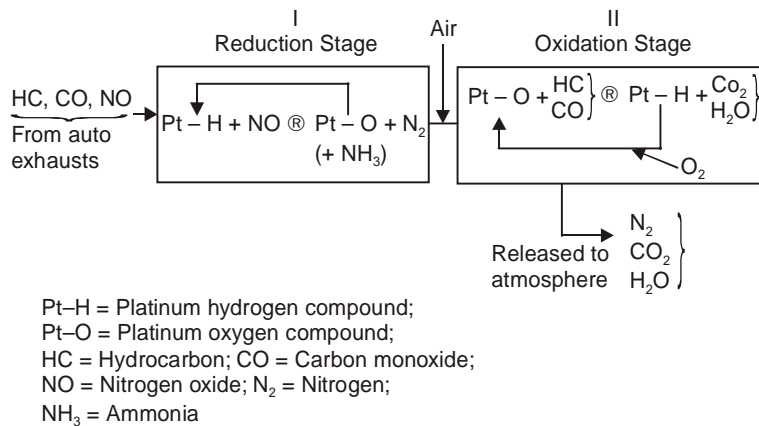

**Fig. 6.5** Catalytic converters for treating auto emissions

Thus by means of platinum catalytic converters, auto exhaust emissions are cleaned up through reduction-oxidation reactions. In all developed countries it is mandatory by law for all automobiles to fit their engines with catalytic converters. In India some automobile companies have plans to fit their automobile engines with catalytic converters.

### 6.5.5 Nitrogen Oxides, NO<sub>x</sub>

It consists of mixed oxides, nitric oxide and nitrogen dioxide (NO and NO<sub>2</sub> respectively)—the former is a colourless and odourless gas but the latter (NO<sub>2</sub>) has a reddish brown colour and pungent smell.

The formation of NO and NO<sub>2</sub> is based on the chemical reactions:

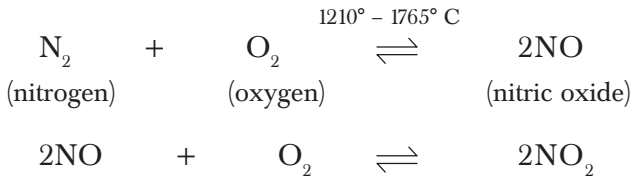

These reactions occur inside the automobile engines so that the exhaust gases consist of NO<sub>x</sub>. The latter concentration in rural air is much less than in urban air.

In air NO<sub>x</sub> is converted into nitric acid, HNO<sub>3</sub> by natural processes:

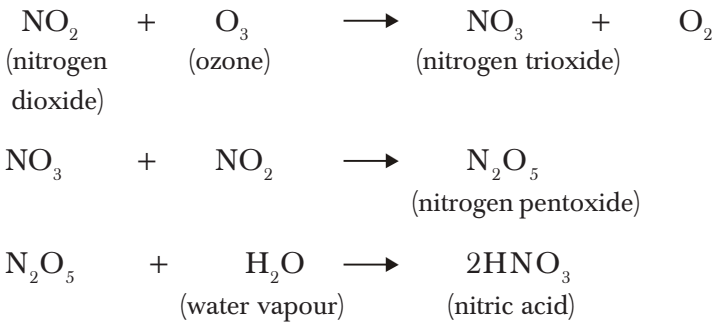

This nitric acid is one of the constituents of acid rain discussed in a subsequent section. From auto exhaust emissions NO<sub>x</sub> is removed as discussed above by means of catalytic converters.

### 6.5.6 Hydrocarbons and Photochemical Smog

Natural processes, particularly trees, emit large quantities of hydrocarbons in air. Methane, CH<sub>4</sub> is a major hydrocarbon. It is generated in large quantities by bacteria formed by anaerobic decomposition of organic matter in water, sediments and soil.

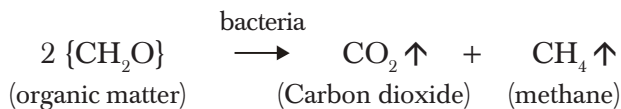

Domestic animals (cattle, buffaloes, etc.) contribute about 85 million tons of methane to the atmosphere each year. Automobiles are significant sources of hydrocarbons.

In presence of ozone, carbon monoxide, nitrogen oxides and hydrocarbon participate in photochemical reactions (in presence of sunlight). A chain reaction proceeds in which the free radical  $RCH_2\cdot$  is generated in the first step. Other free radicals which are formed are:  $RCH_2O_2\cdot$  in the second step by reaction with oxygen,  $RCH_2O\cdot$ ;  $RCH_2O\cdot$  in the third step by reaction with nitric oxide;  $HO_2\cdot$  in the fourth step by reaction with oxygen—a stable aldehyde  $RCHO$  is another product at this stage;  $HO\cdot$  is formed in fifth step by reaction with nitric oxide (nitrogen dioxide is another product here); and finally, the starting free radical  $RCH_2\cdot$  is regenerated by reaction with hydrocarbon,  $RCH_3$  thereby sustaining the chain reaction.

The harmful products in the chain reaction are  $NO_2$  and aldehyde,  $RCHO$ . A side reaction also follows by another route through the aldehyde,  $RCHO$ ; it gives an injurious end product, peroxy acyl nitrate (PAN) which is a strong eye irritant. These reactions lead to photochemical smog formation, which is characterized by brown hazy fumes which irritate the eyes and lungs and also cause serious damage to plants.

Photochemical smog occurs in coastal cities in winter climate, e.g. in Los Angeles, USA which have the heaviest vehicular traffic.

### 6.5.7 Sulphur Dioxide, $SO_2$

Sulphur dioxide is a colourless gas with a pungent odour. It is produced from the combustion of any sulphur-bearing material.

Sulphur dioxide,  $\text{SO}_2$  is always associated with a little of sulphur trioxide,  $\text{SO}_3$ .

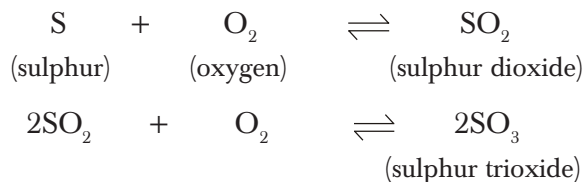

Man-made sources—coal-fired power stations and other industries contribute about 33 per cent of  $\text{SO}_x$  pollution while natural sources, viz. volcanoes provide about 67 per cent of  $\text{SO}_x$  pollution.

Soot particles containing metal oxides, catalyze the oxidation of sulphur dioxide to trioxide.

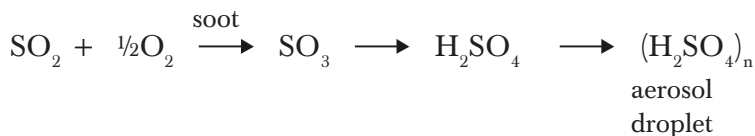
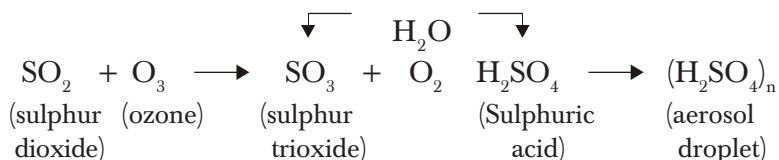

The first reaction above occurs in presence of ozone and water vapour. The product, sulphuric acid is formed on aerosol (fine particle suspended in air as in smoke, fog, mist, etc.) droplet. Sulphuric acid is one of the constituents of acid rain.

In winter sulphur oxides from thermal power plants along with other gases leads to *smog* formation, e.g. *London smog*. This is known as reducing smog in contrast with photochemical smog which is known as oxidising smog (consisting of hydrocarbons, nitrogen oxides and ozone). *London smog* (1952) is well-known for its disastrous effect. Heavy smog ( $\text{SO}_2$ )

conditions prevailed in London for five days which killed about 4,000 people. The causes of death were bronchitis, pneumonia, and other respiratory troubles particularly among aged people.

### 6.5.8 Control of SO<sub>x</sub> Pollution

SO<sub>x</sub> (sulphur oxides) from flue gases of industrial plants can be removed by means of chemical scrubbers. The flue stack gases are led through a bed of (slurry) of limestone, CaCO<sub>3</sub> (calcium carbonate) which absorbs sulphur dioxide quite efficiently.

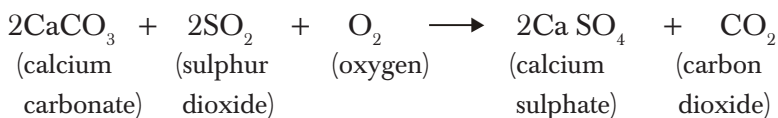

The method is economical but the disposal of solid waste, calcium sulphate is a problem.

Alternatively, sulphur oxide in aqueous solution is treated with citric acid salt and the resulting solution is exposed to a stream of hydrogen sulphide gas whereby sulphur is deposited. This sulphur can then be recovered and utilised.

Thermal power plants, major sources of man-made SO<sub>x</sub> pollution, are normally constructed with tall chimneys to disperse the emissions over a wide area. This reduces the local problem but creates problems for far away areas through acid rains (*see* below).

### 6.5.9 Acid Rain

It has been described above that much of nitrogen oxides, NO<sub>x</sub> and sulphur oxides, SO<sub>x</sub> entering the atmosphere are transformed into nitric acid (HNO<sub>3</sub>) and sulphuric acid (H<sub>2</sub>SO<sub>4</sub>) respectively. These combine with hydrogen chloride, HCl from HCl emissions (both by man-made and natural sources) and generate acidic precipitation, known as *acid rain*.

Acid rain is a major environmental issue as it badly damages the environment. It damages buildings and structural materials of marble, limestones, slate and mortar. These materials become structurally weak as calcium carbonate reacts with sulphuric acid to form soluble sulphate, which is leached out by rain water:

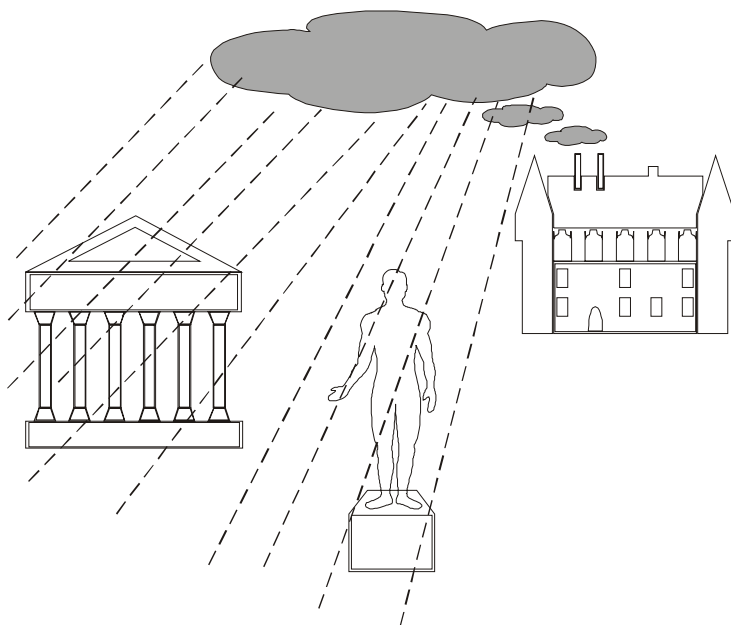
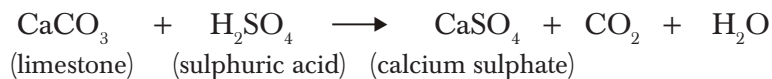

**Fig. 6.6** Acid rain in Greece and Italy

In Greece and Italy invaluable stones and statues have been partly dissolved by acid rain. Besides these, acid rain damaged forests in Germany and lakes in Sweden and Canada. Acid rain originated from U.K. but far away in Sweden, it damaged some 8,000 lakes of which 4,000 are dead. Similarly, acid rain from USA damaged lakes and forests in Canada. In India,



Taj Mahal is threatened by acid rain from Mathura refinery and other industries.

### 6.5.10 Control of Acid Rain

Acid rain can be checked if its constituents, sulphur oxide and nitrogen oxide are controlled as discussed above.

### 6.5.11 Particulate

Small solid particles and liquid droplets are collectively termed *particulates*. They originate both from natural and man-made sources. Every year natural sources discharge 800–2,000 million tons and man-made sources 200–500 million tons of particulates. Among man-made sources, fly ash from thermal power plants deserve mention. Table 6.3 gives a list of annual production of particulate matter from the two sources.

**Table 6.3** World-wide Addition of Particulate Matter to the Atmosphere (in Million Tons)

<i>Particulate matter</i>	<i>Annual Production</i>	
	<i>Natural source</i>	<i>Man-made sources</i>
Total particles	800–2000	200–450
Dust and smoke	—	10–90
Salt, forest fires	450–1100	—
Sulphate	130–200	130–200
Nitrate	30–35	140–700
Hydrocarbons	15–20	75–200

Particulates range in size from  $0.0002 \mu$  (about the size of a molecule) to  $500 \mu$  ( $1 \mu = 10^{-6}$  metre). The number of particles in the atmosphere vary from several hundred per  $\text{cm}^3$  in clean air to more than 100,000 per  $\text{cm}^3$  in highly polluted air (urban/industrial area).

## Soot

Soot particles originate from fuel combustion and consist of highly condensed product of polycyclic aromatic hydrocarbon (PAH)—roughly 100 condensed aromatic rings. The hydrogen content of soot is 1–3 per cent and oxygen content 5–10 per cent due to partial surface oxidation. Due to large surface area, soot acts as a carrier for toxic organics, e.g. benzo- $\alpha$ -pyrene and toxic trace metals, e.g. beryllium, cadmium, chromium, manganese, nickel, vanadium, etc.

A soot particle has an average size  $0.1\text{--}20\mu$ . The finer particles ( $< 3\mu$ ) are the worst causes of lungs damage due to their ability to penetrate deep in our respiratory tract and thence in lungs where they remain for years and cause all sorts of diseases such as cough, bronchitis, asthma, and finally cancer. Particulates cause increased corrosion of metals which assume serious dimensions in industrial and urban areas. They are responsible for damage to buildings, sculptures, paintings, etc.

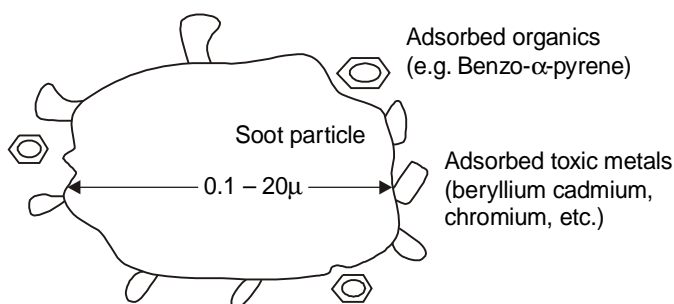

**Fig. 6.7** A soot particle

Particulates play key roles in the atmosphere. They reduce visibility by scattering and absorption of solar radiation. They influence the climate through the formation of cloud, rain and snow by acting as nuclei upon which water can condense into raindrops. Atmospheric particulate levels can be correlated with the extent of precipitation over cities and suburbs.

### 6.5.12 Control of Particulate Emissions

The removal of particulate matter from gas streams is an essential step for air pollution control. The best equipment is the *Electrostatic Precipitator*.

Electrostatic precipitator is based on the principle that aerosol particles acquire charge when subjected to an electrostatic field.

$$F = Eq$$

where  $F$  = force in dynes to which particles are subjected,

$E$  = voltage gradient and

$q$  = charge on the particles (esu)

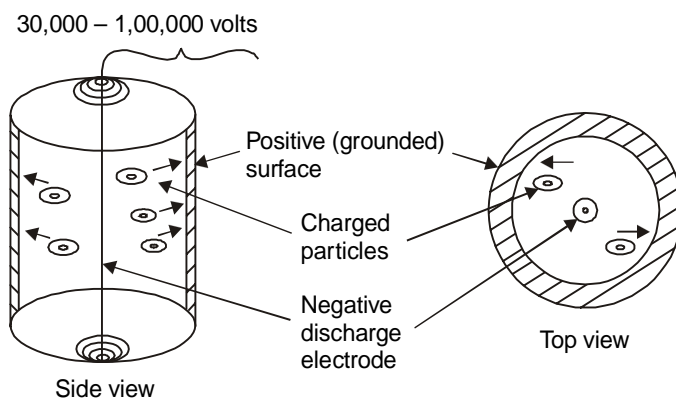

**Fig. 6.8** Electrostatic precipitator

The particles acquire a charge when a gas stream is led through a high voltage (30,000–100,000 volts) DC (direct current)–corona (electrical discharge under high voltage). The charged particles are attracted to a grounded surface from which they are recovered.

### 6.5.13 Air Pollution and Biosphere

Air pollutants are present largely in the troposphere and lower stratosphere. The ground air, 1–100 metres high, is very much

polluted in urban and industrial areas. Some pollutants are absorbed on vegetation, buildings and water surfaces.

The primary pollutants discharged into the atmosphere, undergo chemical changes in presence of water vapour, oxygen and solar ultra-violet radiation and produce secondary pollutants.

Carbon dioxide	→	Carbonic acid
Hydrogen sulphide	→	Sulphuric acid
Sulphur dioxide	→	Sulphuric acid
Nitrogen oxides	→	Nitric acid

These pollutants (secondary) have harmful effects on soil, vegetation, crops, animals, men and materials.

Plants are affected both by gaseous pollutants and by particulates deposited on soil. Acid rain over a period of time tends to reduce the soil pH ( $= \log H^+$  i.e. negative logarithm of hydrogen ion concentration which is an index of acidity, alkalinity or neutrality) and renders it acidic and less fertile. Moreover, deposition of toxic metals on soil in industrial areas makes the soil unsuitable for growth of plants. Some plants are very sensitive to traces of toxic metals as the latter inhibit the action of some plant enzymes.

Particulates such as dust and soot are deposited on plant leaves and block the stomata (opening in the epidermis of plants). This restricts the absorption of carbon dioxide and hence reduce the rate of photosynthesis as well as rate of transpiration. The overall result is retarded growth of plants and decreased yield of crops. In California, USA the presence of sulphur dioxide in air and metallic pollutants in soil killed vegetation in an area of 300 km<sup>2</sup> and affected growth on a further 350 km<sup>2</sup> of land. In Leeds, U.K. there was drastic decrease in growth of lettuce and radish in heavily polluted industrial areas compared to less polluted areas of the city.

Ozone and peroxyacetyl nitrate (PAN) (in photochemical smog, see previous section) are oxidising agents which attack

plants by oxidising their sulphhydryl (–SH) groups of proteins into disulphides. This leads to inhibition of individual enzyme activity. They also affect photosynthesis by plants.

Cattle are affected by air pollution, particularly under smog conditions. They develop breathing troubles, loss of appetite and show low milk yield while many of them die.

Man has become the victim of air pollution. Thousands of chemicals pose the problems of health hazards during manufacture and handling. A typical list of 24 extremely hazardous substances in the atmosphere has been submitted by the United States Environmental Protection Agency (1973):

- Acrylonitrile, Arsenic, Asbestos, Benzene, Beryllium, Cadmium, Chlorinated solvents, Chlorofluorocarbons, Chromate, Coke oven emissions, Ethylene oxide, Lead, Mercury, Ozone, Sulphur dioxide, Vinyl chloride, Toxic waste disposal emissions and leachates (washings), etc.

#### 6.5.14 Meteorology and Air Pollution

Air pollution, one of the man-made activities, has some impact on meteorology, i.e. the science of atmospheric phenomenon. Meteorology is based on the physical parameters such as temperature, wind, moisture, and movement of air masses in the atmosphere. It is also affected by the chemical properties of the atmosphere and the chemical reactions going on in the atmosphere.

The air pollutants get dispersed in the atmosphere depending on the patterns of air circulation. In this context *temperature inversion* plays an important role. It occurs when a warm air mass moves above a cold air mass resulting in air stagnation of the latter (cold air) in which air pollutants get trapped. The air above the ground becomes polluted. This happens when warm air blows over a mountain range and over cool air on the other side of the range. Such a phenomenon is observed in Denver, USA on the east of the Rocky mountains.

Human activities are partly responsible for changing the meteorology of the earth. These activities are:

1. Deforestation and loss of forest cover;
2. Shifting of surface water and ground water in large amounts;
3. Release of heat from power plants;
4. Emission of particles and trace gases into the atmosphere;
5. Release of carbon dioxide into the atmosphere by combustion of fossil fuels;
6. Emission from transport system into the lower and upper atmosphere.

The loading of particulate matter into the atmosphere influences the climate. It has been shown in Table 6.3 that each year natural sources are injecting about 800–2,000 million tons while man-made sources about 200–400 million tons of particles in the atmosphere. As already discussed, particles induce cloud formation and rainfall. It has been calculated as an approximation that if the particle loading increases by 50 per cent, the average temperature of the earth will decrease by about 0.5° C to 1° C due to particle-induced cloud formation. This partly counterbalances the temperature rise due to Greenhouse Effect.

## 6.6 AIR QUALITY STANDARDS

Each pollutant, present in air, has a *threshold limit value (TLV)* which, if exceeded, causes public health hazards. Table 6.4 gives a list of typical pollutants with their threshold limits (TLV). For factory workers TLV sets the limit of exposure for 40-hour week (8 hours a day) without adverse effects. These TLV values are determined mainly by experiments on animals.

**Table 6.4** Threshold Limit Values (TLV) for Some Common Pollutants (Gases and Vapours)

<i>Pollutant</i>	<i>Threshold Limit Values</i>	
	<i>ppm</i>	<i>mg/m<sup>3</sup></i>
Acetone	750	1780
Ammonia	25	18
Arsenic	0.2–0.5	—
Benzene	10	20
Cadmium-	—	0.05
Carbon dioxide	5000	9000
Carbon monoxide	50	50
Carbon tetrachloride	5	30
Chlorine	10	30
Chloroform	10	50
Hydrogen chloride	5	7
Hydrogen sulphide	10	14
Lead	—	0.2
Nitric oxide	25	30
Ozone	0.1	0.2
Sulphur dioxide	2.0	5.0
Vinyl chloride	5	10

## 6.7 NOISE POLLUTION AND HEALTH

Noise is part of our environment. With progress in industrialisation, the noise level has been rising continuously. In the 19th century the development of the steam engines, petrol engine and machines in factories resulted in increasingly noisy environment. In the 20th century this was further accelerated by introduction of diesel engine, jet engines, turboprop, high tech machineries, construction site machineries and automobile traffic. Noise has been recognised as one of the dimensions of pollution which brings about degradation of the environment and creates health and communication hazards.

### 6.7.1 Sound and Human Acoustics

Sound consists of wave motion in an elastic medium such as air, water or solids (e.g. metals, plastics, wood, bricks, etc.). Sound waves travel through the medium from the source to the recipient or listener. The rate of the oscillation of the medium is known as the *frequency* of the sound, the unit being *Hertz (Hz)* or *cycles per second*. The frequency is a measure of the pitch of the sound received by the listener. High frequencies mean high pitched sounds which are more irritating to the individual than low frequencies. The second parameter of sound is *sound pressure* which is measured in Newtons per sq. metre ( $\text{N/m}^2$ ). The third parameter on sound is its *intensity*, expressed in watts per sq. metre, i.e. the quantum of sound energy that flows through unit area of the medium in unit time.

The human ear receives sound waves which set up oscillations in the ear drum (tympanic membrane). These oscillations cause movement of three small bones in the middle ear behind the ear drum. These then pass through the fluid in the inner ear to the auditory nerve and finally transmitted to the brain. The oscillations or sound are intensified and interpreted in the brain, which can select sounds into different categories—speech, music, noises, etc.

The sensitivity of the ear varies from person to person. With ageing, people lose hearing power gradually. A young person, 18 years old, with normal hearing, has audio range between 20 Hz and 20,000 Hz. The audio sense is sharpest in the frequency range 2000–8500 Hz.

### 6.7.2 Noise Measurement Units

As mentioned before, sound pressure and sound intensity are two important parameters of noise. The common scientific acoustic unit is the **Decibel (dB)**<sup>1</sup>. It is not an absolute physical

---

<sup>1</sup> 1 Decibel (dB) = log intensity measured/reference intensity.



unit like volt, metre, etc. but is a ratio, expressed in logarithmic scale relative to a reference sound pressure level.

The reference intensity used in the threshold of hearing which means sound which can be first heard at a sound pressure of  $2 \times 10^{-5}$  Newtons per sq. metre or sound intensity of  $10^{-12}$  watts per sq. metre.

Noise meters have been designed for noise measurement from low to high frequencies, characteristic of human ear capacity. These meters record the dB scale for routine measurement of general noise levels. Refined noise meters have been developed to take care of peak noise levels, duration of noise exposure and quality of noise which are aspects of specified noise situation.

**Table 6.5** Sound Measurement (Intensities, Pressures and Decibels) in Air at Room Temperature and Sea Level Pressure

<i>Intensity</i> ( $Wm^{-2}$ )	<i>Pressure</i> ( $Nm^{-2}$ )	<i>dB</i>	<i>Sound Source</i>
100	2,00,000	200	Saturn rocket take off
1.0	20	120	Boiler shop
$10^{-2}$	2.0	100	Siren at 5 metres
$10^{-4}$	0.2	80	Heavy machinery
$10^{-6}$	0.02	60	Normal conversation at 1 metre
$10^{-8}$	0.002	40	Public library
$10^{-12}$	$2 \times 10^{-8}$	0	Threshold of hearing

### 6.7.3 $L_{10}$ (18 hours) Index

This is used for road traffic measurement, adopted in UK for noise legislation. The index is expressed in dB—it is the arithmetic average hourly values of the noise level exceeded for 10 per cent of the time over 18 hours between 6:00 and 24:00 hours on any normal week day. It includes peak noise

values and fluctuation of noise depending in the type of vehicle and traffic density.

#### **6.7.4 Effective Perceived Noise Level (L<sub>epn</sub>)**

This is recommended for aircraft by the International Civil Aviation Organisation (ICAO) as the standard for use in noise evaluation. The index is based on the scale equivalent to the dB scale +13 and takes care of the peak frequency of jet aircraft noise as well as duration of aircraft flyover.

#### **6.7.5 Noise Classification**

There are broadly three categories of noise:

- (i) Transport noise,
- (ii) Occupational noise, and
- (iii) Neighbourhood noise.

##### *Transport Noise*

Transport noise can be further sub-divided into (i) Road traffic noise, (ii) Aircraft and (iii) Rail traffic noise.

##### *Road Traffic Noise*

Traffic noise is increasing over the years with increase in the number of road vehicles. Traffic speed is the major cause of noise. The noise volume is enhanced with increase in traffic speed. Modern highways and traffic system encourage higher speeds.

In general, on urban roads there are distinct traffic peaks in the morning and evening (10 a.m. and 6 p.m.) as people travel to and fro workplaces. Heavy diesel-engined trucks are the noisiest vehicles on roads at present. The permissible noise levels for cities are prescribed by the Central Pollution Control Board, India are shown in Table 6.6.

These limits are, however, violated in all big cities in India, Calcutta being the worst case. The average noise levels in busy streets in Calcutta during rush hours (between 10:30-12:00 hrs and 18:00-19:30 hrs.) are 90 dB. People live in an environment of noise generated by blasting horns, rumbling tyres and screeching brakes. Awful road accidents contribute to the misery.

**Table 6.6** Permissible Noise Levels (cities)

<i>Areas</i>	<i>Day</i>	<i>Night</i>
Industrial	75 dB	65 dB
Commercial	65 dB	55 dB
Residential	50 dB	45 dB
Sensitive areas up to 100 m around hospitals, schools	50 dB	40 dB

#### *Aircraft Noise*

The noise levels have peak values when aircrafts fly low and overhead or take off and land at airports. The noise limits prescribed by UK airports for take-offs are 110 PNdB (1 PN dB = dB scale + 13) during day and 102 PNdB during night. These may be compared with the values in USA: 112 PNdB during day at New York.

#### *Rail Traffic*

It is less of a nuisance as compared to the previous types of traffic noise.

#### *Occupational Noise*

Industrial workers are exposed to noisy working environment for 48 hours a week (8 hrs. a day for 6 days a week). Some typical occupational noise levels are given in Table 6.7.

Millions of workers suffer from progressive hearing damage and become prone to accidents under their working conditions. Their working efficiency is also affected.

*Neighbourhood Noise*

Loud TV and radio sets, loud cassettes, loudspeakers in public functions, disco music, etc. are sources of neighbourhood noise which disturb and irritate the general public and also harm the patients.

**Table 6.7** Occupational Noise Levels

<i>Industrial Source</i>	<i>Noise Level (dB)</i>
Steel plate riveting	130
Oxygen torch	126
Boilers' shop	120
Textile loom	112
Circular saw	110
Farm tractor	103
Newspaper press	101
Bench lathe	95
High speed drill	85
Supermarket	60

**6.7.6 Noise Pollution Hazards**

The human ear drum is struck by noise in the form of airborne mechanical energy. While the tolerable conversation level is 65 dB at a distance of 1 metre, 125 dB gives the sensation of pain in the ear and 150 dB might be a killer.

High intensity noise for continuous periods is the major cause for ear damage. If a noise level exceeding 90 dB in the mid-frequency range reaches the ear for more than a few minutes, then the sensitivity of the ear is reduced.

Noise pollution can cause pathological or psychological disorders. High frequencies or ultrasonic sound above the audible range can affect the semi-circular canals of the inner ear and make one suffer from nausea and dizziness. Mid-audible frequencies can lead to resonance in the skull and thereby affect the brain and nervous system. Moderate vibration can also cause pain, numbness and cyanosis (blue colouration) of fingers

while severe vibration results damage to bones and joints in the bands with swelling and stiffness.

In industrial and other establishments the general impact of noise pollution is lower efficiency, reduced work rate and higher potential for accidents and injuries.

In residential areas even low frequency noise of 50–60 dB at night disturbs sleep, particularly among the aged people, causing adverse effect on health.

Children, exposed to excessive noise, show signs of behavioural disorder which in later age develop into destructive nature and neurotic disorders in the adult.

Excessive noise is one of the major factors for chronic exhaustion and tension in our daily lives. This may explain why more and more people tend to become addicted to alcohol, tobacco and drugs.

Noise pollution has also impact on travel of migratory birds from winter to tropical climate. Thus the increase of noise pollution in Calcutta and construction of high-rise buildings near Alipur Zoological garden have led to decline in the number migratory birds from CIS (former USSR) from 15,000 in 1980 to 2000 in 1990.

### 6.7.7 Permissible Noise Levels

In this age many people work and live in environment where the noise level is not hazardous. But over the years they suffer from progressive hearing loss and psychological hazards. The maximum permissible noise levels are summarized in Table 6.8.

**Table 6.8** Maximum Permissible Noise Levels

<i>Situation</i>	<i>Permissible Noise, dB</i>
Road traffic near residential areas	70
Ear protection required	85
Factory work (48 hr. week)	105

(Contd)

<i>Situation</i>	<i>Permissible Noise, dB</i>
Prolonged noise causing permanent damage	100
Threshold of pain (30 sec. Duration)	120
Maximum for sonic boom	150
Ear drum rupture	180
Lungs damage	195

### 6.7.8 Control of Noise Pollution

Noise pollution is closely related to increase in industrialisation and urbanisation. It cannot be entirely eliminated but it can be kept at a safe level through adoption of some measures:

- (a) control of noise intensity at the source itself;
- (b) noise absorption measures placed between the noise source and the recipient;
- (c) use of protective measures by the recipient so that the ear drum is saved.

The common noise generation sources are: generators (for power supply), water pumps, loud speakers, cassette playing shops, blowing of air horns in motor vehicles, landing and take off by aeroplanes, noise of machines in factories, etc. The specific laws in this respect should be strictly enforced. This must be backed by public awareness and vigilance.

## 6.8 ODOUR POLLUTION

In our day-to-day life we come across various aromatic (odourous) substances. Fragrant flowers give off sweet fragrance which charm us and give us aesthetic (sense of beauty) pleasure. But there are substances such as garbage heap, rotten fish, eggs and meat, sewage water, etc. which give foul odour, intolerable to us. Air pollution due to odourous substances may be called *odour pollution*.

### 6.8.1. Odourous Pollutants

1. *Garbage*—Foul odours are emitted from roadside vats containing decomposed garbage heaps. A typical garbage heap consists of metal scraps, glass bottles, paper, plastics, cocconut shells, tin cans, left over food, etc. These are in fact composed of waste inorganic and organic matter. The organic substances on fermentation produce volatile chemical compounds and discharge obnoxious odour. Inhalation of such foul odour causes irritation and nausea. In Calcutta itself (metropolitan area) about 3000 tons of solid wastes are dumped on the streets, 25 per cent of which remains there for more than 24 hours. The area surrounding the garbage vats or roadside heaps is surcharged with foul odour which affects the health of local residents and passers by.
2. *Public Urinals, Toilets*—In public places such as roadsides, railway stations, markets, hospitals, institution buildings, etc. public urinals and toilets emit foul odour which becomes a public nuisance. The pungent odour of emitted ammonia is unhygienic and offensive.

In rural areas it is a different scenario. Here defecation in open spaces is a traditional practice of rural people. This is a public nuisance which is unhygienic for rural people and cause severe water pollution in nearby ponds, tanks, etc. affecting the health of villagers.

3. *Poultry, Piggery, Cattle shed, etc.*—Poultres emit a foul-smelling gas viz. hydrogen sulphide due to rotten eggs. Piggeries give off methane, ammonia and hydrogen sulphide which have bad odour. Cow dung on fermentation in cattle sheds yields methane and ammonia having offensive odour.
4. *Morgue*—In morgues decomposed dead bodies after postmortem dissection emit nasty odour which pollutes the surrounding air and the locality. Furthermore,

decomposition of dead carcasses of animals after natural calamities such as cyclone, flood, etc. cause severe odour pollution all around.

5. *Manholes, Unused Wells, Drains, etc.* – Manhole emits foul odour when its lid is open. Very old unused wells and drains which are not cleaned regularly also give similar foul odour. It is known that persons working inside manholes or unused wells die of gas poisoning. It is also a matter of common experience that unused canals or drains stink (emit disgusting odour) due to fermentation of organic wastes, mud and slush. Examples are choked canals in Calcutta viz. Kalighat (Adi Ganga), Tolly Nalah, Beliaghata, Kestopur and Bagjola canals.

#### 6. *Industrial Odourous Pollutants*

The typical industries discharging odourous pollutants are listed in Table 6.9.

**Table 6.9** Industrial Sources of Odourous Pollutants

<i>Industries</i>	<i>Odourous Pollutants</i>
Tanneries	Stench from leather processing and tannery effluents
Fertilizers	Ammonia, Bone dust
Petroleum	Sulphur dioxide and Sulphurous compounds
Paper	Sulphurous compounds
Coke ovens	Ammoniacal and sulphurous compounds and phenolic compounds
Food Processing	Dairy waste, stale meat products

Artificial colouring and flavouring agents, added to food products, cold drinks, confectionaries, etc. in the market to make them more attractive in colour and flavour e.g. tomato sauce, cold drinks, sweets, cakes, etc. are harmful for our health. Fragranat volatile organic liquids which are used as



solvents or otherwise in nail polish, lipstick, perfumes, etc. and in computers have adverse effect on our health.

### 6.8.2 Control of Odour Pollution

The sources of odour pollution should be kept away from residential areas. Solid wastes should be cleared daily and not allowed to accumulate for days.

Cattle sheds, poultries, piggeries, etc. should be situated beyond the residential areas. Public toilets and urinals must be regularly cleared up by the authorities concerned (municipalities, railways, etc.) and the public should put pressure on the latter to do the job.

Morgues should be located outside populated areas. An enclosure of selected perennial (lasting throughout the year) trees containing fragrant flowers around the morgues may reduce the spread of foul odour.

Municipalities and the public should keep constant vigilance so that the lids of the man-holes in the streets are not kept open or removed. The old wells, draw-wells should be cleaned from time to time so that poisonous gases do not accumulate in these wells.

The tanneries and other odour-polluting industries should be outside the residential limits and adequate pollution control measures adopted by these industries.

It is advisable to avoid use of cheap perfumes, nail polish, coloured confectioneries, sweets, drinks, etc. Use of deodorisers is recommended for control of foul odours. These deodorisers have good smell and suppress obnoxious odour. Deodorisers such as odonil are recommended in toilets. Disinfectants such as formaldehyde destroy bacteria, fungi, etc. which create bad odour.

### Key Terms and Concepts (Glossary)

*Acid Rain:* Rain water containing mixtures of acids (nitric, sulphuric and hydrochloric acids), from polluted air is known

as acid rain. It is harmful for the environment as it damages lakes, forests and marble sculptures. Power plants (plants for generation of electricity) discharge gases which carry the ingredients of acid rain to far away places and cause acid rain there.

*Air Pollution:* Various gaseous pollutants from natural and man-made sources enter the atmosphere and have adverse effect on the normal properties of air. This leads to air pollution which is harmful for man and environment.

*Air Pollutants:* Gases and particles which cause air pollution are called air pollutants. These are carbon monoxide, nitrogen oxides, sulphur oxides, hydrocarbons and particulates (solid particles).

*Air Quality:* Each pollutant in air has a limiting concentration, which if exceeded, causes public health hazards. This sets the air quality standards, which should be maintained in the interest of public health.

*Decibel:* Unit of sound intensity, abbreviated as dB.

1 decibel (dB) =  $\log$  intensity measured/reference intensity

*El Nino:* Ocean warming phenomenon occurring every two to five years (January–March) in the Pacific ocean. A mass of warm water moves along the Pacific coast of South America. It causes storms and heavy rainfall along Chile coast (South America) and spreading up to California (USA) and affects climate over half the globe up to Australia. El Nino kills fish in Peru (South America) and affects Peruvian economy. El Nino is the Spanish term for child Christ (it starts by December end).

*Greenhouse Effect–(Global Warming):* Rise in temperature of the earth's surface due to increase in the levels of greenhouse gases viz. carbon dioxide, methane, etc. The latter trap heat from the earth's surface and returns it thereby raising the earth's surface temperature. The phenomenon is similar to trapping

of heat in glass-covered green house (used for growth of vegetables and flowers during winter) and hence called Greenhouse Effect.

*Greenhouse Gases:* Gases such as carbon dioxide, methane, water vapour, etc. which absorb earth's infra-red radiation, return it to the earth's surface thereby raising its temperature (Global warming).

*Mesosphere:* The region of the atmosphere at an altitude of 50–100 km. and located above the stratosphere.

*Meteorology:* The science of atmospheric phenomenon. The physical parameters are temperature, moisture, wind speed, movement of air masses in the atmosphere.

*Montreal Protocol:* An International Agreement under the auspices of United Nations in Montreal Conference (1987). It was agreed that ozone hole be reduced by banning the production of chlorofluorocarbons by 2000 AD in developed countries and by 2010 in developing countries such as India.

*Noise Pollution:* Noise above the tolerable level (50 decibels), disturbing the environment and causing health hazards e.g. hearing loss, dizziness, exhaustion, etc.

*Odour Pollution:* Air pollution due to odourous substances giving off offensive smell is called odour pollution. Garbage, public urinals, toilets, poultry, cattle shed, manholes, etc. are sources of odour pollution.

*Ozone Hole:* The ozone layer in the stratosphere acts as a protective shield for all life forms on earth against harmful ultraviolet radiation from space. This becomes very thin, called ozone hole, due to destructive action of chlorine molecules (source: chlorofluorocarbons), nitrogen oxides, etc. on ozone molecule. The ozone hole was first observed in 1979 over Antarctica and later on over northern hemisphere—increase in number of skin cancer cases have been reported. It was

decided under Montreal Protocol (1987) to ban production of ozone-depleting chemicals and reduce the ozone hole.

*Particulate:* Solid particles or liquid particles suspended in air. Examples are soot particles from combustion of fossil fuels.

*Soot:* Dark particulate matter arising from combustion of fossil fuel power plants and vehicles. Finer soot particles are dangerous for health as they cause respiratory disorder and disorders and diseases.

*Stratosphere:* The region of the atmosphere at an altitude of 11–50 km. above the earth's surface. Here ozone is the important constituent which acts as a protective shield against ultraviolet radiation and saves life on earth.

*Thermosphere:* The region of the atmosphere, 85–500 km. above the earth's surface and just above the mesosphere.

*Troposphere:* The bottom region of the atmosphere, at an altitude of 0–11 km. It contains 70 per cent of air masses which are always in motion. Here temperature decreases uniformly with increasing altitude.

## QUESTIONS

1. What are the major regions of the atmosphere? Give their respective altitudes and temperature ranges. What are the important chemical species in these regions? Give your answer with a table and figure only.
2. Name the major, minor and trace constituents of the atmosphere. Give their percentage composition by volume.
3. "Carbon dioxide is a non-pollutant but it is of much environmental concern." Explain with reference to the Greenhouse Effect.
4. What is Greenhouse Effect? Describe its impact on global climate, food production and world geography.

5. What are the Greenhouse gases? What are their relative contribution to Greenhouse Effect?
6. What are the primary air pollutants? Describe their sources, and state their annual production figures (in million tons).
7. How would you control carbon monoxide. and nitrogen oxides in automobile exhaust emissions?
8. How will you control sulphur dioxide and particulate emissions from thermal power plants?
9. Write explanatory notes on:
  - (a) Ozone hole
  - (b) El Nino
  - (c) Acid rain
  - (d) Photochemical smog
  - (e) Effect of air pollution on public health
  - (f) Effect of air pollution on Meteorology
  - (g) Air Quality Standards.
10. What are the units of noise measurement?
11. How would you classify noise under different categories?
12. Discuss the impact of noise on our health.
13. What are the permissible levels of noise in (a) residential areas, (b) business and (c) sensitive areas?
14. Suggest measures for noise pollution control.
15. What is odour pollution?
16. Name the odourous pollutants and their sources.
17. Suggest methods for control of odour pollution.



---

# Energy and Environment

## 7.1 CONVENTIONAL ENERGY RESOURCES

The invention of steam engine in 1780 brought about Industrial Revolution in Britain. In 1799 Volta invented the battery, the first source of electric current, In 1820 Michael Faraday demonstrated a device—dynamo, for production of electricity using “dynamo” (electro-magnetic induction). Electricity generation using heat of steam marked the beginning of thermal power production in the middle of 19th century.

The demands on energy are increasing with progress in human civilization. The quality of life or standard of living is linked with the quantum of energy consumption. In USA per capita energy consumption is 200 million British thermal units, BTU (1 BTU = energy required to raise the temperature of 1 lb. of water by 1° F), 125 million BTU in UK, 50 million BTU in Japan and only 5 million BTU in India. But generally much of the energy (about 60 per cent) is wasted. Maximum wastage is observed in power plants and vehicles.

The conventional energy resources are fossil fuel (coal, petroleum and diesel), wood, natural gas, hydroelectricity and nuclear energy. The energy, as consumed by man, is: 33 per cent from petroleum and diesel, 27 per cent from coal and 5 per cent from nuclear fuels.

### 7.1.1 Coal

Coal is substantially more abundant than oil or gas, the total reservoir being  $7 \times 10^{12}$  metric tons which is equivalent to  $5 \times 10^{22}$  calories. This is 1000 times more than the total global energy consumption from all fuels. The stock of coal is likely to last several centuries.

The natural defect of coal is that it is a dirty fuel to burn. On combustion, it emits sulphur dioxide which is an offensive gas which forms sulphuric acid in air and causes acid rain in far away places. Thus it poses environmental hazards (*see* acid rain in previous chapter). Excavation of coal from mines is followed by soil subsidence (depression) which endangers the residential areas above the coal mines. Moreover, fly ash arising from combustion of coal is a nuisance as solid waste which brings about environmental problems. Also being a solid, coal is less convenient to handle than petroleum or natural gas.

In order to overcome these problems, the developed countries use less polluting forms of coal by transforming it into gaseous, liquid or low sulphur, low ash solid fuel. In a typical case, high grade ash-free coal is produced as solvent-refined coal (SRC) by suspending pulverized coal in a solvent and treating with 2 per cent of its weight of hydrogen at a pressure of 1000 pounds per sq. inch and  $450^{\circ}$  C. The product is a semi-solid, m.p.  $170^{\circ}$  C having a calorific value of 16,000 BTU per pound. This compares well with the best grade anthracite coal.

### 7.1.2 Thermal Power

Electricity is generated by combustion of coal in a furnace. This heat is utilised to produce steam at high temperature and pressure. The latter is then used to run a steam turbine which is linked with the generator producing electricity.

Thermal power stations are operated on the above principle by combustion of coal in a furnace.

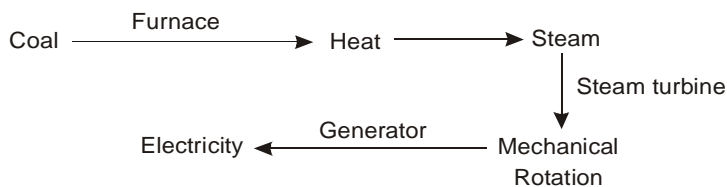

Thermal power contributes about 65,000 mega watts (MW) of electricity i.e. 70 per cent of India's power supply. Some of the major thermal power stations of the National Thermal Power Corporation (NTPC) of India are at Singrauli and Rihand in U.P., Talchar in Orissa, and Farakka in West Bengal. They are the sources of severe air pollution.

### 7.1.3 Methanol, CH<sub>3</sub>OH

It is a convenient liquid fuel which can be produced from coal. On a commercial scale, it is produced by the reaction of carbon monoxide, CO and hydrogen, H<sub>2</sub> at 50 atmospheres pressure and 250° C in presence of copper-based catalyst. The reactants (CO and H<sub>2</sub>) are obtained from coal, oxygen and steam:



15 per cent methanol makes an excellent additive to gasoline which improves fuel economy and also cuts down the emission of practically all automotive pollutants.

### 7.1.4 Petroleum or Mineral Oil

The consumption of petroleum and natural gas is maximum in the developed countries and has become the status symbol of a country. USA is the largest consumer of petroleum in the world (about 80 per cent of total energy consumption in USA).

The Industrial Revolution (1780) was initially fuelled by coal but later on preference was given to oil and gas which



provide cleaner fuels and easy transportation. The world reserve of petroleum is about 800 billion barrels (1 barrel = 31.5 gallons = 120 litres) which will last for less than 100 years.

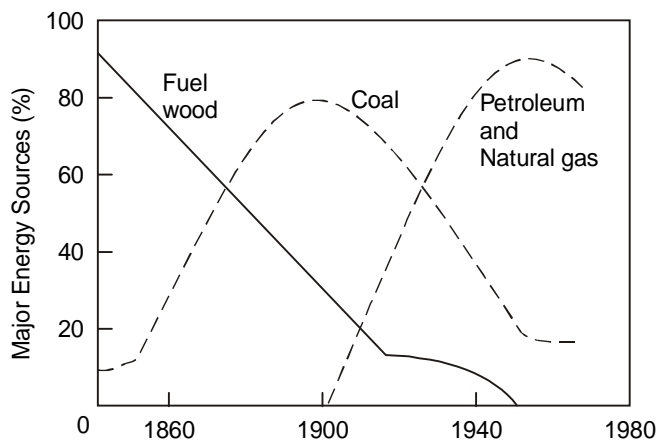

Fig. 7.1 Energy consumption patterns in USA

### 7.1.5 Hydroelectricity

The output from hydroelectricity (electricity from water) accounts for 21 per cent of total electricity generation, which is less than that from thermal power but greater than that from nuclear power. In Venezuela, South America 10,000 megawatts of hydroelectricity are produced which are equivalent to the production of electricity from 10 thermal power plants. In India, if water resources are properly utilised, it may be possible to generate more than 10,000 megawatts of electricity. But at present only 16 per cent or 6,500 megawatts of hydroelectricity are generated.

For generation of electricity from hydel project it is necessary to utilise energy produced from the descent of water from higher to lower level. In practice, a water reservoir is constructed by means of dam in a river for storage of water. Subsequently the stored water is released from upper level

into a water-driven turbine placed at a lower level (Fig. 7.2) whereby electricity is generated. The Hydel Projects of Maithon, Panchyot and Jaldhaka are typical examples.

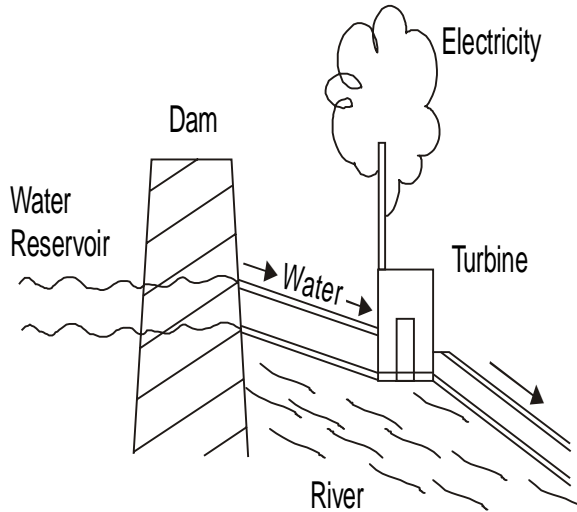

**Fig. 7.2** Hydroelectricity from hydel project

The merits of hydroelectricity are: (1) clean source of energy; (2) no emission of greenhouse gases; (3) no consumption of fuel; (4) no need of high technology. But there are several environmental issues—flora and fauna in the region are disturbed due to construction of dam; local people become refugees as they are uprooted from their houses; the capacity of the reservoir gets reduced due to siltation; occurrence of floods in the area when surplus water has to be discharged in monsoon season. Hydroelectric dams are costly and take a long time for construction. In order to make hydroelectricity generation viable, it is necessary to adopt a long-term programme of afforestation, environmental conservation, housing, public health and transport and ensure close co-ordination among these departments.

### 7.1.6 Nuclear Power

It contributes only 5 per cent of total electricity generation. Nuclear power plants do not emit polluting gases such as carbon dioxide, sulphur dioxide, like thermal power plants. But they have some severe drawbacks, viz. they are costly and they release large quantities of radioactive fission products.

The radioactive wastes remain lethal (deadly) for thousands of years and for this no foolproof disposal method has been devised. That is why big nuclear power projects have not succeeded in the long run.

In India the production target was fixed at 10,000 megawatts by 2000 AD, but the actual production is much less in the nuclear power stations at Tarapur, Rajasthan and Chennai. Nuclear power plants cannot match thermal power plants at present but in future, its unlimited resources will allow it to dominate the energy scenario when other energy resources are exhausted.

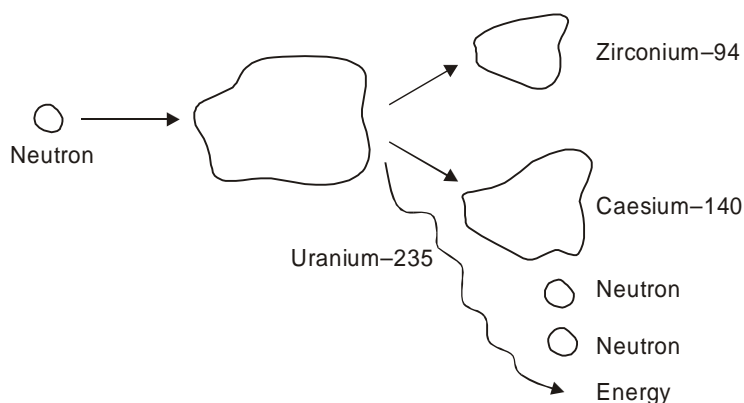

**Fig. 7.3** Nuclear fission

At present nuclear fission is used to produce nuclear power. Heavy large atoms like Uranium and Plutonium split up into smaller atoms when bombarded by neutrons (nuclear particles with mass 1 and zero charge). This splitting or fission liberates

vast amounts of energy, which through conventional techniques is converted into electricity. Thus nuclear power is generated.

It has been calculated that 1 kg of Uranium-235 on a complete fission by slow neutrons releases energy equal to  $1.7 \times 10^{13}$  calories. This means energy-wise, 1 lb. of Uranium-235  $\equiv$  5 million lbs. of coal  $\equiv$  20 million lbs. of T.N.T (highly explosive chemical).

This is the secret of nuclear energy/power.

### 7.1.7 Wood

Wood is a major renewable natural resource. The major important products are wood, paper, cellophane, rayon, plywood, plastic, particle board, turpentine, methanol, etc. In USA the production of wood and wood products is the fifth largest industry. Ideally, as in USA forests cover 38 per cent. of the total land area; in India it has come down to about 15 per cent at present from 80 per cent, two thousand years ago.

It is interesting to compare between India and USA in respect of deforestation. In USA the Sunday issue of the leading newspaper, New York Times consisting of 500 pages requires 25 hectares (1 hectare = 2.5 acres = 7.5 bighas) of forest. According to an estimate, an American destroys as much forest for his needs for paper as an Indian for his domestic fuel. The value of a 50-year old tree has been estimated as about more than Rs 20 lakhs—the various functions of a 50-year old tree are roughly evaluated as follows:

(i) Oxygen production (for 50 years)	Rs 2,50,000
(ii) Transformation into protein	Rs 20,000
(iii) Control of soil erosion and soil fertility	Rs 2,50,000
(iv) Recycling of water and control of humidity and atmospheric temperature	Rs 2,50,000

(v) Habitat for birds and other animals and insects, etc.	Rs 2,50,000
(vi) Control of air and heat pollution	Rs 5,00,000
<b>Total</b>	<b>Rs 15,20,000</b>

This estimate excludes the value of timber/wood for furniture, fuels, medicines, etc. which will be an extra Rs. 3–4 lakhs.

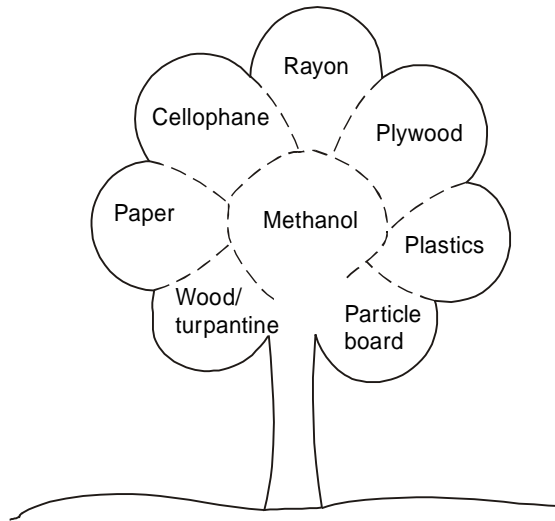

**Fig. 7.4** Trees—sources of many important products

Thus the tree, with its 50-year services as above, costs about Rs 20 lakhs (1980 estimate) which at present market prices, will be around Rs 40 lakhs. The public should be made aware of the value of a tree and its services to man and environment during its life time.

In India 76 per cent of population lives in villages—almost all of them use wood as fuel for cooking. This is the main reason for extensive deforestation in rural areas: each year we are losing about 1.3 million hectares forests. Deforestation helps increase in greenhouse gas, carbon dioxide concentration. Hence for the welfare of the country as a whole, it is essential

to minimise deforestation by adopting, alternative resources of afforestation on a large scale to meet the needs of domestic fuel.

### 7.1.8 Natural Gas

It is better fossil fuel than coal and petroleum since on burning, it produces less carbon dioxide. For production of one unit of energy, mineral oil, coal and wood, on burning, produces 35 per cent, 75 per cent and 80–90 per cent more carbon dioxide than natural gas. Hence natural gas is the obvious choice as a cleaner fuel. Its reserve, however, are limited and can continue to feed only for the next 70–80 years. At present, in India the exploitable reserve of natural gas is about 700 billion cubic metres.

## 7.2 NON-CONVENTIONAL ENERGY RESOURCES

### 7.2.1 Solar Energy

India, being a tropical country, is blessed with abundant sunshine, 2,000 kilowatt hour/sq. metre (kWh/m<sup>2</sup>) per year for about 200–300 days in a year. The daily sunshine is between 5–7 kWh/m<sup>2</sup>. This is an enormous and model energy resource, which is clean, pollution-free and inexpensive. It requires to be converted into other forms of energy by suitable techniques—it can meet our energy demands for ever. The solar energy, incident on earth in one week, is equivalent to the energy from the entire coal reserve of the world. Again the solar energy available on earth for 45 minutes is enough to meet our energy demand for one year.

However, the major problem is that sunlight is diffuse (widespread) in nature and difficult to be stored and utilized. But with advance technology, the present high costs may be cut down so that solar energy can be utilized on a large scale in future. At present, solar energy is ten times more expensive

than thermal power. But with advance technology, it will be cheaper and hold the key to meet our energy demands in future.

Sunlight may be directly converted into electricity through photovoltaic cell. The latter is a device for conversion of light energy into electrical energy. The efficiency of conversion of light into electricity is only 18 per cent and it is expensive at current prices. We can use solar energy in two ways: (1) use of solar heat and (2) use of solar electricity. Use of the former permits one to boil water or dry foodgrains. Accordingly, several gadgets have been produced such as solar cooker (for cooking), solar dryer (for drying grains), solar water heater (for heating water), solar distillation (for water purification), etc. Recently there have been extensive use of these solar equipments in rural and semi-urban areas. By using the second method, i.e. solar cell, sunrays are converted into electricity. Since these solar cells are made of silicon, these are called silicon cells.

The advantages of solar photovoltaics are that they can replace systems which use diesel and they are free from chemical and noise pollution. They could be installed in remote areas in forests and deserts where installation of electric cables are cost-prohibitive.

Solar power, with government subsidy (Department of Non-conventional Energy Source, DNES, Government of India) is being used in remote rural areas in West Bengal in the forms of solar lanterns, solar streetlight and solar pump (for irrigation). Solar powered small pumps are being used in Delhi, Haryana and Himachal Pradesh. It is desirable to use solar cookers in villages on a large scale so that extensive deforestation can be prevented. About 1 ton of wood per head per year can be saved by this process.

Figure 7.5 illustrates a detailed design for a solar heated house during winter in developed countries like USA. In these countries 20–25 per cent of fuel is consumed for providing

hot water to houses and buildings. Sunlight is collected on plates in the roof and the heat transferred to a circulating water system. An average house with roof area about 1300 sq. ft. in central USA can get its energy supply for heating and hot water supply in December by this method. This may well apply to hill station houses in India in Jammu & Kashmir, Nainital, Mussorie, Darjeeling, etc. in December-January.

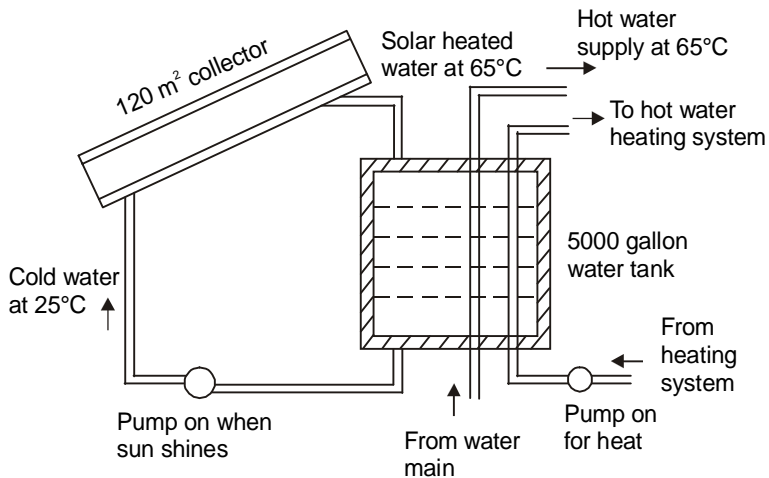
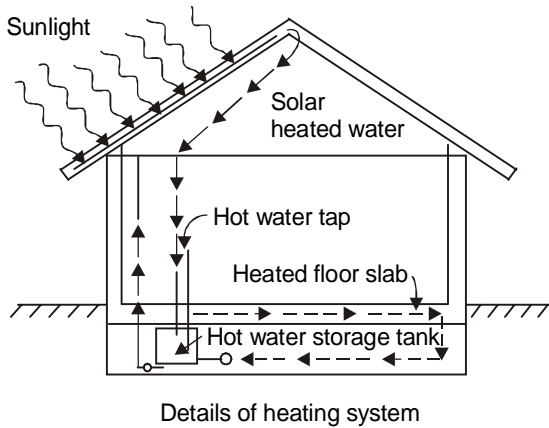



Figure 7.6 illustrates the function of a solar cell. Light is absorbed in a plate, with the generation of positive and negative charges, which are collected at the electrodes on either side. The silicon solar cell, developed for space programmes, consists of a sandwich of a *n*-type and *p*-type silicon semiconductors (e.g. silicon, germanium is a crystalline substance which is intermediate between a metallic conductor on one hand and non-conducting insulator on the other)—the charge separation is developed across the junction between them. *p*-type silicon conducts positive charge while *n*-type silicon conducts negative charge. The silicon cell produces electricity but is quite expensive since very high-grade crystalline silicon is required for the cell.

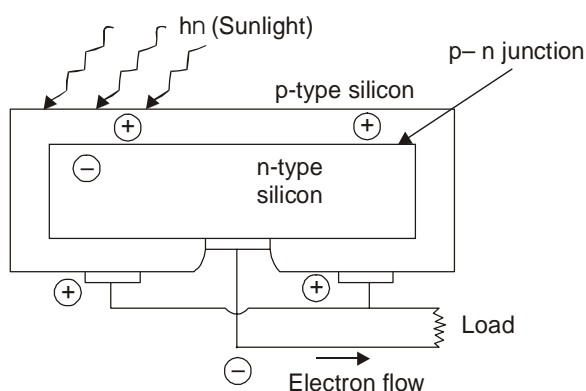

Fig. 7.6 Solar cell for electricity generation

### 7.2.2 Biogas

This offers an important solution to the present energy crisis in rural areas. Besides being an important domestic energy source, it offers an environmentally clean technology. There is a vast reserve of biogas in Indian villages. It is estimated that 1000 million tons of animal dung per year is available from 250 million cattle population. On an average 10 kg of wet dung is available per animal per day, which at 66 per cent

collection efficiency, can yield 22,500 million cubic meters of biogas through biogas plants. This can replace kerosene oil whereby 14,000 million litres of kerosene per year can be saved in villages. Besides biogas slurries can produce 200 million tons of organic manure per year which can be good substitute for chemical fertilisers for agriculture.

The composition of the biogas is: methane, carbon dioxide, hydrogen and nitrogen. The proportion of methane and carbon dioxide varies considerably as does the calorific value. At 40 per cent methane content, the calorific value is 3200 kcal/cubic metre, while at 50 per cent, it is 4500 kcal/cubic metre.

### 7.2.3 Wind Energy

This is a cheap and clean energy resource. India, with its climatic diversity, has areas which are quite windy. According to the Indian Meteorological Department, average annual wind velocity of 6.5 metres per second at a number of places in peninsular India as also along coastlines in Gujrat, Western Ghats and parts of Central India. Such velocities are available for 6–7 months in a year.

There are some limitations for setting up of wind power mills or wind mills. They require locations where the wind velocity is at least 6.5 metres per second. In Denmark and Holland there are rows of wind mills in extensive areas and these generate 50 megawatts of electricity. A standard wind mill produces 55 kilowatts of electricity daily. Windmills spread over extensive areas on sea shore or very high site present a beautiful scenario. Windmills prevent earthquakes where continuous wind flow causes soil erosion. In Scotland, Wales, Sweden, Germany and USA many wind mills have been constructed for cheap generation of electricity.

The technology for harnessing wind energy has become commercial in some developed countries but in India it is still in the preliminary stage. The Department of Non-Conventional Energy Sources, Government of India has installed several

wind pumps with pumping capacity of 20 metres. A wind mill with a capacity to pump 400 litres of water per hour at a pumping head of 19 metres has been installed. Prospective sites are in Gujrat and Orissa on the sea coast. A 100 km. stretch of coast in areas having wind speed of 10 km/hour from sea would lead to an installed capacity of 5000 megawatts. Wind energy can be used advantageously in remote rural areas and would help in saving fossil fuels.

#### **7.2.4 Ocean and Tidal Energy**

Ocean waves splash on ocean shores at tremendous speed—the mechanical energy in this process can be harnessed and converted into electrical energy. It has been found that in the middle of North Atlantic Ocean each wave per 1 metre height can generate 90 kW electricity whereas on the oceanshore the waves can generate 25–70 kW. During storm the generation level can rise up to 5 megawatts. Lot of research is on in this area in U.K, Canada, Norway and Japan.

In a large chamber the sea water is enclosed by oscillating water column method. Ocean/sea wave enters the chamber through an inlet pipe and forces the enclosed water upward at terrific speed—it will exert hydraulic pressure on enclosed air which in turn can rotate a turbine. Such method is expensive at present but it has immense potential which can be exploited in future with advance technology.

#### ***Tidal Wave***

Tidal wave can also be tapped for generating electricity. During flow tide sea water enters river—it is possible to store such sea water in a big tank and rotate turbines by the mechanical force in the process and generate electricity. It is necessary that about 3–5 meters high sea water through flow tide enters the chamber. USSR (now CIS) and China have built small tidal power plants. In India the probable sites for exploration of tidal energy are the Gulf of Kutch and Cambay and Sundarbans and also near

Andaman, Nicobar and Lakshadweep islands. The sites should be within 20–30 km from the shore in order to facilitate power transmission to the islands.

### 7.2.5 Geothermal Energy

The earth's core has a vast source of thermal energy, which has been tapped in many developed countries. In France and Hungary, hot water from hot springs has been utilised for heating houses and agricultural farms. Italy is the pioneer in this field. Later on USA, Philippines, Japan and New Zealand have been working on exploration of geothermal energy as an energy resource.

During the oil crisis period in 1973, England developed the technology for harnessing geothermal energy. If in many areas wells are dug about 5 km. deep, then geothermal energy may be exploited. With advanced technology, it may be possible to generate electricity from geothermal energy in India and other developed countries.

### 7.2.6 Energy Plantation

#### *Energy Production from Wastes*

Energy can be produced from wastes—agricultural, industrial and municipal wastes.

Agricultural wastes are mainly crop residues. They are dried and used as fuel. Straw, jute sticks and other crop residues are burnt by villagers for cooking and partial boiling of paddy.

In certain industries the waste materials can be utilised as a source of energy. Food processing, jute, sugar, paper and textile industries are the major industries where the waste materials can be utilised for the production of heat and electricity. Various processes have been developed for effective use of bagasse, jute, cotton and paper industries for energy production.

Both solid and liquid municipal wastes can be utilised as the source of energy. Bio-degradable materials in the municipal wastes can be converted into biogas through bacterial anaerobic digestion. Solid municipal wastes can be dried and formed into pellets for use as fuel.

### **Key Terms and Concepts (Glossary)**

*Biogas:* Gas (energy source), usually methane mixed with carbon dioxide, produced from animal dung e.g. gobar gas from cowdung. This non-conventional energy resource is useful fuel for rural areas.

*Conventional Energy Resources:* Usually traditional energy resources such as fossil fuel (coal, petroleum and diesel), wood, natural gas, hydroelectricity and nuclear energy.

*Energy Plantation:* Trees are natural renewable energy resources. Plantation of trees (afforestation) on land is known as energy plantation. This is necessary for raising a new forest cover to make up for deforestation. The major important products of energy plantation are wood, paper, cellophane, rayon, plywood, plastic, etc.

*Geothermal Energy:* The heat energy coming out of the very hot earth's core e.g. hot springs. Harnessing geothermal energy would save fossil fuels and has been tried in several developed countries.

*Hydroelectricity:* Electricity generation from water dam or reservoir. It is a conventional, clean energy resource, which accounts for 21 per cent of total electricity generation.

*Methanol:* Conventional liquid fuel which can be produced from coal. It is manufactured from carbon monoxide and hydrogen, which, in turn, are obtained from coal, oxygen and steam.

*Non-conventional Energy Resource:* Solar energy, wind energy, ocean and tidal energy, geothermal energy and biogas belong

to the category of non-conventional energy resources. Solar energy is the most promising non-conventional energy resource for India. It is lean, pollution-free and inexpensive.

*Natural Gas:* Cleaner fuel than fossil fuel as it produces less carbon dioxide on burning than fossil fuel (coal, petroleum, etc.)

*Nuclear Power:* Electricity (power) generated from nuclear fission i.e. splitting of nucleus (plutonium) into two or more fragments with liberation of tremendous amount of energy.

*Petroleum (mineral oil):* An important fossil fuel (underground reserve) used as conventional energy resource, mostly in the developed countries since 1950. USA is the largest consumer of petroleum at present in the world. The world reserve at the present rate of consumption is likely to last less than 100 years.

*Solar Energy:* The most abundant and clean source of energy (non-conventional) for India. Sunlight is directly converted into electricity through photovoltaic cell (device for conversion of light energy into electrical energy). Solar energy can be used as solar cooker, solar heater, solar lanterns, solar pumps, etc. in remote rural areas and thereby save wooden fuel.

*Thermal power:* Coal, on combustion in a furnace, generates steam at high temperature and pressure which is then used to run steam turbine and generate electricity. This is the basis of thermal power production which, however, causes severe air pollution.

*Tidal Energy:* Energy associated with tidal wave (3–5 metres high) can be tapped for generating electricity. On the ocean shore 1-metre high tidal wave can generate 25–70 kilowatts of energy.

*Wind Energy:* This is cheap and clean energy resource in India. Wind power mills can be set up along coastlines (in Gujarat, Western Ghats) where wind velocity 6.5 metres per second

gives optimum conditions for running wind mills. The technology for harnessing wind energy has become commercial in developed countries (Denmark, Holland, Sweden, etc.).

## QUESTIONS

1. Name conventional and non-conventional sources of energy. Compare their effects on environment.
2. What are the products of combustion of coal and petroleum? Discuss their damaging effect on environment.
3. Starting from coal, how would you manufacture methanol and obtain Solvent Refined Coal (SRC)?
4. Discuss: "Solar energy is the energy for future in India". Suggest how solar energy can meet the energy demands of rural and urban India in future.
5. Write critical notes on:
  - (a) Biogas
  - (b) Tidal wave energy
  - (c) Hydroelectricity
  - (d) Geothermal energy
6. Comment on: "Wood is a major renewable energy resource; it offers multiple benefits to man. But it is vanishing fast".



---

# Environment and Public Health

## 8.1 POLLUTION AND PUBLIC HEALTH ISSUES

Very few people have paid any attention to the dark side of industrialisation, particularly to the growing dangers it poses to the health of people. Hardly a day passes when hundreds do not succumb to the accidents or diseases caused by growing pollution of the environment in general and the increasing occupational hazards or die in major industrial disaster as in Bhopal.

Industrialisation is creating a high-risk environment for all. But it is the poor labourers/workers who suffer the most. They get the dirtiest and most hazardous job and are compelled to live in the dirtiest environment in close proximity to the industries. The society benefits from the industries but at the cost of the poor workers who are most neglected.

### 8.1.1 Hazardous Products

During the last 50 years about 6 million chemicals have been synthesised at the rate of 10,000 new ones every month. Some 60,000–70,000 chemicals are used extensively in millions of



different commercial products. The world produces chemicals—faster than it can manage.

These chemicals include extremely toxic substances which can cause allergies, damage vital organs of the human body like the eye, brain, liver, kidney and reproductive organs, produces deformities in babies during pregnancies of mothers and promote cancer. In case of accidental release into the environment in large quantities, as in case of Bhopal, they can lead to mass murder. What is amazing is that we know nothing about the toxic effect of 80 per cent of the chemicals used.

Industries which produce potentially toxic and hazardous wastes are pesticides, dyes and pigments, organic chemicals, fertilisers, non-ferrous metals, steel and chlor-alkali manufacturing plants.

The major locations of such industries are Delhi, Udaipur, Kanpur, Chandipur, Bokaro, Jamshedpur, Rourkela, Calcutta, Raipur, Ahmedabad, Baroda, Mumbai, Hyderabad, Visakhapatnam, Bangalore, Chennai and Cochin. Bhopal is not included in the list, which shows that unlisted factories can cause major disasters.

**Table 8.1** Toxic Chemicals—Uses and Hazards

<i>Name</i>	<i>Uses</i>	<i>Hazards</i>
Arsenic	Pesticides/Unani medicines/glass	Toxic/dermatitis/muscular paralysis/Damage to liver and kidney/Loss of hair/gangrene/cancer
Asbestos	Roofing/insulation/Air-conditioning roofs/Plastics/fibre/paper	Carcinogenic to workers and family members
Benzene	Gasoline additive/Manufacture of many Chemicals	Leukemia/chromosome damage

(Contd)

<i>Name</i>	<i>Uses</i>	<i>Hazards</i>
Beryllium	Aerospace industry/ Ceramic parts/ House-hold appliances	Fatal lung disease/ heart and lung toxicity
Cadmium	Electroplating/plastics/ Pigments/ superphosphate Fertilisers	Kidney damage/ carcinogenic
Chlorinated Organics (DDT, BHC, etc.)	Pesticides/ fungicides	Nervous depression/ carcinogenic
Chromates	Tanning/Paints/ Pigments/Corrosion inhibitors/Fungicides	Skin ulcers/kidney inflammation/ carcinogenic
Lead	Pipes/storage batteries/ Paints/printing/plastics/ Gasoline additive	Neurotoxin/blood system and brain damage
Manganese	Mining/welding/dry cell Battery/ferromanganese Material (alloy)	Nerve damage/damage to reproductive system
Mercury	Chloralkai cells/ fungicides/ Pharmaceuticals	Nerve damage/kidney damage/fatal effect of alkyl mercury
Polychloro- biphenyls (PCB)	Transformers/ insulation of electricity	Carcinogenic/nerve, skin and liver damage
Sulphur dioxide	Sugar industry	Irritation to eyes and Respiratory system/ damage to plants/ damage to marble structures, monuments, etc.
Urea	Fertiliser	Bronchial problems/ kidney damage
Vinyl chloride	Plastics/organic synthesis	Toxic/carcinogenic

Phosphatic fertiliser factories and thermal power plants generate large quantities of conventional solid wastes which are stored near the sites. Some 5 million tons of byproduct phosphogypsum are generated at 12 major phosphatic fertiliser plants. 20 per cent of this waste is used to produce ammonium sulphate, while the rest containing thousands of tons of heavy metals and toxic metals such as chromium, copper, lead, manganese and fluorides are dumped into low lands for land filling or into lagoons in the form of slurry.

Thermal power plants, which produce more than 50 per cent of electricity generated in India, are other major sources of solid wastes. Fly ash, the solid waste, accumulates in mountainous heaps near the power stations or carried as slurry into ponds and rivers where it creates serious water pollution problems. Fly ash itself contains toxic metals such as beryllium, cadmium, zinc, arsenic, manganese, etc.

From pesticide industries some 15 tons of DDT and 25 tons of BHC (hexachlorobenzene) are carried as wastes every year which ultimately travel in the environment, enter our food chain and finally enter our body tissues where they are retained. Indians have shown maximum DDT content (25 ppm) in body tissues in the world. For the last 40 years DDT has been banned in the western countries but it is still being used as before in India.

### 8.1.2 Occupational Hazards

Workers in mines, factories, commercial firms, forestry and agriculture are exposed to risks, high to low, which are called the *occupational hazards*. According to the United Nations, some 2 lakh workers die each year throughout the world due to accidents and occupational diseases. Another 10 millions suffer from non-fatal injuries.

### 8.1.3 Deadly Dust

The worst occupational diseases are caused by dust. These are broadly termed lung diseases (pneumoconiosis) and their

effect depends on the nature of dust, its fineness, concentration, period of exposure and the victim's health.

#### **8.1.4 Silicosis**

It originates from dust containing free silica or silicon dioxide. It was first reported in 1947 in India in the Kolar gold mines and then found to occur in various other mines and industries—coal, mica, silver, lead, zinc and manganese mines and pottery and ceramics, sand blasting, metal grinding, building construction, rock mining, iron and steel industry and others.

In Bihar's mica mines 33 per cent workers suffer from silicosis. The slate pencil factories in MP villages employ the entire village population where people do not survive beyond 40 years. Children have to work to support their mothers and often succumb early to the diseases. According to an NGO report, the workers "sign their own death warrants for economic reasons".

#### **8.1.5 Asbestosis**

Asbestos is the Greek expression for "unquenchable". Because of its versatility—it resists heat and moisture—it is largely used in home construction, insulation of buildings and ships and also in car brake linings. Besides it finds some 3,000 different industrial applications where it has to be processed into proper size. The finest fibres, invisible to the naked eye, are the most dangerous as they find ready access to our respiratory tract, line the air tubes and accumulate in the lungs.

The silica dust (from asbestos fibres), deposited in the lungs, causes pulmonary fibrosis leading to respiratory problems and death—in severe cases, it causes cancer of the air tubes and gastrointestinal tract. In UK people living within 1 km. of an asbestos factory were reported to be suffering from cancer. What is really alarming is that cancer may strike 5–10 years after exposure.

### 8.1.6 Byssinosis

Some 2 million textile and cotton mill workers are victims of byssinosis. Cotton emits lot of dust in various stages of its processing. The disease strikes 10 years after exposure. It progresses step by step, starting from temporary sickness of wheezing and coughing to permanent breathlessness which shortens life span. Incidence of byssinosis from 6 to 20 per cent has been reported in cotton textile mills in Ahmedabad, Mumbai, Delhi, Kanpur, Chennai, Madurai and Nagpur.

### 8.1.7 Pneumoconiosis

It is commonly associated with mines and known as the source of “black lungs”. Coal mine workers who are long exposed to coal dust lose their capacity to work hard and succumb to the disease which leads to tuberculosis and death.

### 8.1.8 Child Labourers

India has a bad image abroad for employing the largest number of child labourers (16–18 million/age group 8–14). The International Labour Organisation (ILO) reports that the child labourers are underpaid (Rs 2.00–6.00 per day) for 12–16 working hours and they have to toil under inhuman conditions. The brass industries of UP, carpet industries of Kashmir and match factories of Chennai employ most of the child labourers. The “Sibkasi” match factories (in Chennai) employ some 50,000 children (8–12 years old), 80 per cent being girls, who work for 14 hours a day under inhuman conditions. Most of them are vulnerable to accidents and do not live beyond 40 years.

## 8.2 EPIDEMIOLOGY

Hippocrates’ suggestion over 2000 years ago that environmental factors can influence the occurrence of disease

is believed to be the origin of epidemiology. However, it was not until the middle of the 19th century that the distribution of disease in specific human population groups was measured to any great extent. The first epidemiological study was made by Snow in 1854. He identified that the risk of cholera in London was related, among other things, to the drinking water supply by a particular company in London. On the basis of epidemiological studies, Snow suggested that cholera was spread by contaminated water.

Following Snow's work, public health measures, such as improving water supply and sanitation, have made notable contributions to the health of populations. Since 1854, epidemiological studies have provided the information required to identify the measures to be taken.

Epidemiology may be defined as the study of the distribution and determinants of health-related states of events in specified populations and the application of this study to the control of health problems.

### **8.2.1 Hygiene**

Hygiene is closely related to epidemiology. It is defined as the science of health that includes all factors which contribute to healthy living. The purpose of hygiene is to allow man to live in healthy relationship with his environment.

Personal hygiene includes all those factors which influence the health and well-being of an individual. It comprises day-to-day activities for rigorously observing the elementary rules of hygiene for keeping ourselves physically fit and mentally alert through neat and clean habits as our way of life. Our daily routine should involve maintaining regular habits, e.g. taking meals at regular hours, body care (bath, wash, care of teeth, nails and hair, exercise, etc.) use of neat and clean dresses, work and sleep at fixed hours, etc. In other words, we should enforce strict discipline and hygiene in our daily lives. Any disruption of such activities will affect our health. For example,

improper care or negligence of teeth leads to pyorrhoea and dental carries (cavities); dirty skin gives scabies, eczema, dermatitis and fungal infection; lack of sleep causes loss of concentration, mental depression and inability to work with vigour; dirty nails are home for ova of intestinal parasites, etc. The habit of washing hands with soap and water before eating will reduce the risks of diseases such as diarrhoea, dysentery, etc.

### 8.2.2 Health and Disease

According to the World Health Organisation (WHO), health is a state of complete physical, mental and social well-being and not merely the absence of disease or infirmity.

Diseases are due to disturbances in the delicate balance between man and his environment. Three ecological factors are responsible for a disease—Agent, Host and Environment. The disease agent is identified in a laboratory. For example, hepatitis can be identified by the presence of anti-bodies in blood in a laboratory. The host (patient) is available for clinical examination. But the environment from which the patient comes is mostly unknown. The prevention and control of a disease depends on the knowledge of environment. Without the knowledge of environment, it is difficult to cure the disease.

Depending on the sources, diseases can be classified under the categories—(i) Water-borne disease, (ii) Air-borne disease, (iii) Food-borne disease and (iv) Vector-borne disease, which have water, air and food respectively as the sources for (i)–(iii). In vector-borne disease (iv), it is transmitted by various vectors such as mosquitoes, flies or animals. Various agents like viruses, bacteria, parasites are responsible for the diseases. Some common diseases are tabulated in Table 8.2.

**Table 8.2** Some Common Diseases

<i>Type</i>	<i>Disease</i>
Vector-borne disease	Malaria, Filaria, Encephalitis, Dengue, Kalazar, etc.
Water-borne disease	Cholera, Bacillary dysentery, Amoebiosis, Diarrhoea, Viral hepatitis, Poliomyelitis, Typhoid, etc.
Air-borne disease	Influenza, Measles, Chicken Pox, Asthma, Bronchitis, Pneumonia, Tuberculosis, etc.
Food-borne disease	Cholera, Dysentery, etc.

### 8.3 VECTOR-BORNE DISEASES AND THEIR CONTROL

#### 8.3.1 Malaria

Malaria (meaning bad air) was so named because of association of the disease with odourous air of swamps, particularly at night. Malaria results from dirty environment and it has been eradicated in most of the developed countries. However, it still exists in the developing countries, e.g. Africa, Brazil, Colombia, Afghanistan, India and Sri Lanka. Every year malaria affects 300–500 million people of the world and kills at least 2 million. In recent outbreaks in India it killed 2000 persons in Rajasthan (1994) and 1000 persons in Assam, Tripura and Bangladesh (1995).

Malaria is characterised by periodic paroxysms of fever, associated with shivering and terminating with sweating. It is caused by various species of parasites *Plasmodium* and transmitted by the vector, *Anopheles* mosquitoes (female). The fever is usually intermittent with tertian (every third day) or quartan (every fourth day) periodicity. The fever may be occasionally remittent and rarely the disease may be steady



throughout its course. There is anaemia and spleen enlargement among the sufferers. The characteristic symptoms appear when the parasites have reached a concentration of about 200 per mm<sup>3</sup> of blood or about 1 billion in the whole body. The fever attacks most commonly between midnight and noon, instead of in the evening. This helps in distinguishing malaria from other intermittent fevers.

The parasites which are responsible for malaria in man are four species of *Plasmodium*. They are *P.vivax*, *P.falciparum*, *P.malariae* and *P.ovale*. *P.vivax* is the commonest and the most widely distributed species, prevalent in both tropical and temperate zones. It is the cause of “tertian” or “vivax” malaria. It has a 48 hour cycle of development in man and is particularly likely to cause relapses. *P.falciparum* is very prevalent in the tropics but does not thrive as far north as *vivax* does. It has a 40–48 hour cycle of development and is the cause of “malignant tertian” or “falciparum” malaria. *P.malariae* is also widely distributed in both tropical and temperate climate but it is less common than *vivax* or *falciparum*. It is the cause of “quartan” malaria. It has a 72 hour cycle. The fourth species, “*P.ovale*” is very rare.

### 8.3.2 Prevention of Malaria

The prevention of malaria requires community effort rather than individual effort. The discovery of DDT in 1939 by Paul Muller opened a new chapter in malaria control. Malaria was identified in 1951 by WHO as a grave threat to public health and several malaria control projects were undertaken. By 1955 the number of cases all over the world dropped by about 33 per cent. Paul Muller was awarded the Nobel Prize for his contribution to eradication of Malaria.

In India, the National Malaria Control Programme was started in 1953. At that time the annual incidence of malaria cases was 75 million with about 1 million deaths—in 1976 there were 6.4 million cases with about 60 deaths. The Malaria

Eradication Programme, launched in 1958 for eradication of malaria within ten years, was not successful. In 1977 the Modified Control Plan was initiated to prevent deaths due to malaria. Spray operations in infected area were done with DDT, malathion. As a result of spraying, mosquitoes die before transmitting the disease. Some mosquitoes live outdoors but they enter houses, bite the people and then run away. In such cases, the breeding grounds of mosquitoes (stagnant water, stored water outside houses) must be sprayed to kill the larvae. Inside houses water must not be kept stored in open pots or containers where the mosquitoes can breed. Storage water tanks should be cleaned at regular intervals.

### 8.3.3 Treatment of Malaria

Quinine, an alkaloid, has been used as an effective drug for malaria for the last 300 years. Other anti-malarial drugs are—chloroquinine, camoquinine, primaquinine, etc. A synthetic vaccine against malaria was invented by a Colombian scientist, M.E. Patarroyo and is on trial in South America. Africa and South East Asia. The clinical trials are still on.

### 8.3.4 Vector Control

The vector control measures have already been described under the respective diseases in this book (pp. 151–155). Here the general outlines will be summarised. Three control methods are generally used—(i) destruction of adults, (ii) destruction of larvae and (iii) elimination of breeding places.

- (i) *Destruction of adults*: In houses, schools, restaurants, etc. mosquitoes, flies and insects can be destroyed by means of ‘aerosol bombs’ from which DDT and oil dissolved in freon under pressure are released. The freon immediately evaporates liberating the pesticides in minute particles (2–10  $\mu$ ). For continued protection residual sprays with DDT or other pesticides in

suspensions or emulsions at the rate of 200 mg per sq. ft. are required.

- (ii) *Destruction of Larvae*: This can be achieved by the application of pesticides as sprays, dusts, granules or pellets for open water pots, cans, jars, etc. and by clearing of shrubs, floating vegetation in water bodies (ponds, etc.) so as to allow fish to eat the larvae. Lowering of water levels in reservoirs prevents breeding on water surfaces. When the water level is lowered, most of the larvae get stranded and die. Chlorinated insecticides (DDT, BHC, etc.) are used as larvicides.

Some fish can play important role in the control of mosquito larvae in natural water or ponds by eating the larvae. Where algae, weeds and debris are removed from water surface, fish can move freely and eat the larvae—in such cases spraying is unnecessary.

- (iii) *Elimination of breeding places*: This is the permanent solution to mosquito control. Small pools of stagnant water must be eliminated and proper drainage system maintained so as to make it unsuitable for breeding. The Vector Control Research Centre at Pondichery undertook cleaning operation of water and sewer systems of Pondichery city in 1982–85. Sea water was used to flush 50 km. of previously clogged drains—mosquito eggs were killed stagnant water pools were filled in, fish were allowed to feed on insects; the single breeding ground was reclaimed and transformed into a public park. This operation killed 99 per cent of the mosquitoes and reduced significantly the risk of transmission of diseases by the vector. The cost of the operation was not high. The Project shows that environmental control measures are very effective in vector control in India.

## 8.4 WATER-BORNE DISEASES

The names of common water-borne diseases are given in Table 8.2. The causative agents for water-borne diseases may be virus, bacteria, protozoa or helminths. The diseases like viral hepatitis (hepatitis A, hepatitis B), poliomyelitis and diarrhoea are caused by virus. The diseases like cholera, bacillary dysentery, typhoid and paratyphoid are caused by bacteria and the diseases like amoebiasis, giardiasis are caused by protozoa. Some common water-borne diseases are discussed in detail in the following section.

### 8.4.1 Cholera

This is a highly contagious disease (water-borne and food-borne), caused by the bacteria, *Vibrio Cholerae*. Typical symptoms are diarrhoea with rice water stool, vomiting, rapid dehydration, muscular cramps and anuria. In severe case, acute renal failure is possible. Epidemics of cholera occurred in the past in India during Kumbha mela or Ardha Kumbha Melas. Outbreaks of cholera were also reported in the past from Maharashtra, Tamil Nadu, Andhra Pradesh, Karnataka, Bihar, Orissa and West Bengal.

The bacteriology of cholera is complicated. *Vibrio Eltor* replaced the classical *V.Cholerae* by the end of 1965. Most of the *Eltor Vibrios* isolated were found to belong to the serotype Ogawa. *V.Cholerae* is a gram-negative, comma-shaped actively motile organism. The *Eltor Vibrios* resemble the true cholera vibrios morphologically, serologically and also biochemically.

### 8.4.2 Factors for Spread of Cholera

#### *Environmental Factors*

Among environmental factors, water, food, and flies play important role in spreading cholera in the community. Cholera vibrios do not multiply in water but they may survive up to

two depending on temperature, pH, salt content, organic matter, sunlight and other factors. In our country there are a large number of uncontrolled water supplies (e.g. polluted river, ponds, canals, etc.) which are major sources of cholera infection. Cholera vibrios can multiply readily in certain foods and drinks like milk, milk products and some varieties of boiled rice. Fruits and vegetables get contaminated when washed or sprinkled with water from infected areas.

### *Social Factors*

Big fairs like Kumbha Mela or Ardha Kumbha Mela where lakhs of people assemble at the river ghats in UP are the most important factor for the spread of cholera. The crowd bathe and drink the same river water (Ganga) and rapidly spread the disease. Cholera is a disease of the poor people who come from low income groups, live in slums under unhygienic and inhuman conditions. They participate in these melas and contaminate the river water.

### **8.4.3 Control of Cholera**

The control of cholera can be achieved by early detection of the disease, isolation of the patients and their prompt treatment, improvement of sanitary facilities along with adequate supply of safe drinking water to the community. Active immunisation and health awareness are also important measures for cholera control.

For early detection, bacteriological examination of stools is required for confirmation of the disease. The disease should at once be notified to the local authority who will send the information to the State Health Authority and finally to the Central Health Authority.

The treatment of cholera consists of rehydration and antibiotics. Rehydration saves life. In case of kidney failure, dialysis is required. The rehydration should be accomplished

either by injecting intravenous solutions of saline (consisting of sodium chloride: sodium bicarbonate: potassium chloride = 5:4:1) or by giving oral fluid containing a mixture of sodium chloride, sodium bicarbonate, potassium chloride and glucose in the ratios of 3.5:2.5::1.5:20 gm. dissolved in 1 litre water. Tetracycline and co-trimoxazole should be administered as antibiotic.

Improvement of sanitation for the entire community and their residential area is the most effective approach for the prevention and control of cholera. Provision for sanitary latrine for every household is essential for checking the incidence of cholera. Water to be used for domestic purposes, viz. drinking, washing, cooking, cleaning utensils, etc. from sources such as rivers, ponds, lakes, canals, etc. should be boiled. The provision of safe drinking water for all is the permanent solution as it will minimise the incidence of cholera. It is also necessary to observe the rules of hygiene rigorously—household pests—flies, cockroaches, etc. should be eliminated; cut fruits and vegetables which are exposed to dust and flies in open markets should be avoided.

#### 8.4.4 Amoebiasis

This is a water-borne disease, defined by WHO as the condition of harbouring *Entamoeba histolytica* with or without clinical manifestations. It has world-wide distribution. The disease is characterised by liquid stools with mucous and blood.

*E. histolytica* are found as cysts or motile trophozoites. They can live outside the human body as cysts. Trophozoites cause ulcer in the large intestine. Some amoebas reach liver through portal vein any may cause hepatitis or abscess. Intestinal and hepatic amoebiasis are the main manifestations of the disease.

The cysts can live for several weeks outside the human body, if kept moist and cool. In a refrigerator they can live in water for 6–7 weeks. They do not survive at moderate temperature, e.g. 50° C.

Man gets the infection through food chain (cut fruits, salads, vegetables, contaminated drinking water, cold drink, etc.). Uncooked food and vegetable can be disinfected by washing with iodine solution (200 ppm) or acetic acid (5–10 per cent) or vinegar. From water cysts can be removed by filtration and boiling. The cysts can be killed in milk by pasteurisation. The diagnosis is usually based on the detection of *Entamoeba histolytica* in the stools.

The antibody of the parasite can be easily detected by Immuno-fluorescence method.

#### 8.4.5 Prevention of Amoebiasis

The disease can be prevented by (i) sanitary disposal of human excreta; (ii) provision of safe drinking water to all (water should be boiled and filtered before drinking); (iii) hygienic kitchen practice (uncooked fruits and vegetables must be thoroughly washed or disinfected as described before; (iv) protection of foods against flies.

#### 8.4.6 Treatment

The drugs usually prescribed by physicians are:

1. Metronidazole (400–800 mg) (Flagyl) to be taken one tablet thrice a day for 5–7 days.
2. Entrozyme (250 mg)–one tablet thrice a day for 7 days
3. Trinidazole (1–2 gm)–one tablet for 3 days
4. Furamide (500 mg)–one tablet thrice a day for 10 days.

### 8.5 PEST CONTROL AND MANAGEMENT (IPM) IN AGRICULTURE

In an agricultural field crops are susceptible to attack by insects, nematodes, pathogens, mites, birds and mammals which together form a complicated interacting *pest complex*. The control

of a pest complex requires careful assessment of the pests and integration of several methods for control/management (Integrated Pest Management, IPM).

### 8.5.1 Pesticides

In the early period of human civilisation it was realised that pests harm crops and transmit diseases to both animals and men. The first use of chemicals to kill pests was in 70 AD when arsenic was recommended to kill insects. In the 16th century the Chinese used arsenic sulphide as an insecticide. During the 20th century lead arsenate was used as insecticide. Paris green (copper acetoarsenite) was used extensively in pools in the tropics for controlling malaria transmitting mosquitoes. However, it is known that arsenical pesticides can persist in the soil for 40 years and damage crops.

Pesticide is the general term for insecticides, rodenticides, molluscides, herbicides, fungicides, etc. The era of synthetic organic pesticides started around 1940. At present there are more than 10,000 different pesticides. They are classified as:

Insecticides	Organophosphorus group (e.g. malathion); Organochlorine group (e.g. DDT); Carbamate group (e.g. Carbaryl)
Herbicides (designed to kill weeds or undesirable vegetation)	Chlorophenoxy acid group
Fungicides (designed to kill fungi and check plant disease)	Dithiocarbamate group; Organometallic group (e.g. phenyl mercury acetate)

The uses of pesticides helped in the eradication of diseases such as malaria (by DDT) and typhus and also in boosting crop production. About 0.1 per cent of the total insects (500 out



of 5 million) are harmful agricultural pests—they are also carriers of human or animal diseases. Their limitation is essential in the interest of food production and public health.

The annual production of pesticides increased from 6000 million pounds (1950) to over 35,000 million pounds (1985). Of these about 1000 million pounds were organochlorine insecticides which persist in the environment. It was estimated that during the first decade of use (1940–50) DDT saved 5 million lives and prevented 100 million serious illnesses due to malaria, typhus, etc. In the agricultural sector, it is estimated that even after effective application of pesticides, pests continue to cause annual losses of about \$ 30 billion (Rs. 1,35,000 crores) on a global scale. This would have been 10 times more without use of any pesticide.

However, subsequent researches have shown that there are appreciable quantities of pesticide residue in the biota and physical environment of the polar regions and in certain birds, mammals and human beings. Indians have shown highest quantity of DDT residue (25 ppm) in their body tissues. The long term ecological hazards of the persistent pesticides led to their ban in Europe, USA but in India they are still used as before.

### 8.5.2 Toxicity of Pesticides

As indicated above, pesticides are substances which are intended to prevent, destroy, repel or mitigate insects, rodents, nematodes, fungi, weeds, etc. Since pesticides are environmental pollutants, much caution, control and regulation is necessary not only at the stage of production but also of handling by users. Since in developing countries like India a large population lives below the poverty line, people are malnourished and are susceptible to immunosuppressive (i.e. weakening of immunity) status, which is further aggravated by pesticides.

Volatile organochlorine pesticides cause epithelial (cellular membrane lining a cavity) damage of respiratory tract of spray

workers. Persistent organochlorine group of pesticides have a tendency to accumulate in fatty tissues of the body. These act on the central nervous system and interfere with axonic (i.e. nerve-cell process of conduction) transmission of nerve impulses. They may cause sensory and equilibrium disturbances, involuntary muscle activity, depression of vital centres, particularly respiration and bring about behavioural change also.

The early symptoms which appear following ingestion include nausea, vomiting and gastrointestinal tract irritation which are followed by tremors, twitching and convulsion. Occupational workers, exposed to pesticides during working hours, suffer from weight loss, headache, nervousness and finally on prolonged exposure, cancer.

Organophosphate pesticides exhibit a wide range of differences in their ability to penetrate skin and show toxicity. They inhibit the function of the enzyme, acetylcholine for nerve transmission. Severe poisoning leads to coma, paralysis and finally respiratory failure.

According to the findings of the World Health Organisation (WHO) some one million people are poisoned by pesticides every year resulting in some 20,000 deaths. Developing countries account for only 30 per cent of the pesticide consumption, but share more than 60 per cent of the casualties. The most horrible pesticide factory accident, which has set a world record in industrial disaster, is that of the Bhopal Disaster (1984) (*see* Chapter 1, Sec. 1.5).

### **8.5.3 Integrated Pest Management (IPM)**

It is known that when insects and other organisms appear as pests in epidemic form, they become tough enemies and in most cases, they cause disaster. In 1967 the Food and Agricultural Organisation (FAO) Panel of experts on integrated pest control defined integrated control as “a pest management system that in the context of associated environment and

population pattern of the pest species, utilise all suitable techniques and methods in a co-ordinated manner so that pest population is maintained at levels below those causing economic damage” (Economic damage occurs when pest causes yield loss and loss of profit by farmers). IPM also means the reduction of pest problems by actions selected after the life systems of the pests are understood and the ecological and economic consequences of such actions have been correctly predicted. This implies use of the model of the pests’ life system as part of the ecosystem involved. The approaches to the population management of pests are—(a) orientation relating to the entire pest population instead of to a localised group; (b) lowering the population density of the pest so that the economic threshold is reduced or eliminated; (c) use of a combination of methods to supplement the effects of natural control agents where possible; (d) reduction of the problem on a long-term basis rather than temporary basis and (e) management of the pest population instead of its eradication.

All over the world the IPM programme is devised for the many different crops in different locations, e.g. tobacco in North Carolina (USA), sugarcane in Louisiana (USA) and Taiwan, etc. The policy of crop protectionists is an IPM programme for all the more important crops in all the major agricultural regions of the world.

#### **8.5.4 Biological Control**

It is based on the application of predators or parasites of a pest to reduce its numbers to a point where it is no longer an economic problem.

The earliest success in USA was the control of the cotton-cushion scale in California, a small insect, native to Australia, that attacks citrus trees. Late in 1800s the Vedalia beetle was imported from Australia and they preyed on the scale insects so effectively that they were almost eliminated from the citrus grooves within two years.

Since then some 500 organisms were imported into USA and released for biological control.

For many pests, however, the predators or parasites that have been tried have not been able to control the pest population. According to ecologists, a good parasite or predator should have high affinity for pests, short life cycle and high fecundity (i.e. productivity). Its climatic requirements should be close to those of the pest.

### 8.5.5 Agents of Biological Control

The parasites of pests are grouped under:

1. *Vertebrates* (e.g. fishes, tadpoles, frogs, snakes, birds, insectivorous birds, squirrel, mongoose, etc.)
2. *Protozoa* (e.g. *Glugea pyroausta* has shown positive results against European cross-borer and *G.legeri* against cabbage butterfly).
3. *Anthropoda* (e.g. spiders, mites and insects)
4. *Micro-organisms* (e.g. spore-forming bacteria–*bacillus popillae* for control of the Japanese beetle)

### 8.5.6 Biotechnological Approach

This is the modern biological line of defence against pests. It finds favour among business communities including multi-national corporations (MNC) for development of pest-resistant crop varieties including genetically engineered ones. The methods are more attractive than chemical pesticides for environmental safety. But they are costly at present. According to agricultural experts, biotechnology has the potential for enormous profits in the long run for agro-industries. They may sell seeds which will yield plants that withstand viruses, pests, show cold tolerance and produce more sugar, starch or particular amino acids. However, caution must be taken to safeguard the environment against any harmful effect of genetically engineered organisms.

## 8.6 ELEMENT (HEAVY/LIGHT METAL) TOXICITY

Many elements listed as environmental hazards (arsenic, cadmium, lead, mercury, etc.) are also essential dietary trace elements required for normal growth and development of plants, animals and human beings. The lines of demarcation between essential and toxic levels are rather arbitrary:

- (a) *Essential* at trace levels for sustenance of life processes;
- (b) *Deficient* at lower levels than (a) causing malnutrition;
- (c) *Toxic* at levels higher than (a) causing system disorder and on occasions, fatal effects.

### 8.6.1 Toxicity of Arsenic

Arsenic commonly occurs in insecticides, fungicides and herbicides. Among its compounds, arsenic (III) is most toxic. Arsenic (III) exerts its toxic action by attacking sulphhydryl groups ( $-SH$ ) of an enzyme thereby inhibiting enzyme action. At high concentrations, arsenic (III) compounds coagulate proteins, possibly by attacking the sulphur bonds and thereby cause metabolic disorder.

The recent incidents of arsenic poisoning due to arsenic-contaminated drinking water in West Bengal and Bangladesh have revealed the toxic action of arsenic which has caused several deaths while lakhs of people continue to suffer from various diseases (*see* Chapter 5: arsenic-contaminated ground water).

### 8.6.2 Antidotes for Arsenic

The general antidotes for arsenic poisoning are chemicals having sulphhydryl groups ( $-SH$ ) capable of bonding with arsenic (III), e.g. 2, 3-dimercaptopropanol (abbreviated as BAL).

### 8.6.3 Toxicity of Cadmium

Cadmium is an inhibitor of sulphhydryl group containing enzymes. It has also affinity for hydroxyl, carboxyl, and phosphate side chains of proteins, purines, etc.

The outbreak of cadmium poisoning occurred in Japan in the form of “*itai itai*” or “*ouch-ouch*” disease. People either consumed rice irrigated with cadmium-polluted water or lived near cadmium smelters and picked up cadmium in their bodies. As a result, their bones became so fragile that they could be fractured with a little mechanical shock due to bumps and knocks. With excess amounts of cadmium injected, it replaces zinc at key enzymatic sites.

### 8.6.4 Toxicity of Chromium

Chromium poisoning occurs among chrome plant workers. Prolonged exposure to chromium (III) and Chromium (VI) by workers in chromium plating industries leads to lesions in lungs, respiratory passage, hypertension and skin disease such as dermatitis, erythema, etc.

### 8.6.5 Toxicity of Lead

Lead is a relatively abundant heavy metal in nature, occurring in lead minerals. In the atmosphere it is more abundant than other heavy metals. The major source of air-borne lead is the combustion of leaded gasoline. Lead is removed from the atmosphere by wet and dry deposition processes. As a result, street dusts and roadside soils are enriched with lead. A typical city dweller has a daily intake of about 225  $\mu\text{g}$  ( $1 \mu\text{g} = 10^{-6} \text{g}$ ) lead from air, water and food out of which 200  $\mu\text{g}$  is excreted and 25  $\mu\text{g}$  is stored in the bones every day.

The major biochemical effect of lead is its interference with heme (blood constituent) synthesis which leads to anaemia, kidney dysfunction and brain damage. Acute lead poisoning results in gastrointestinal disturbances, dyspepsia, constipation,

colic acid and abdominal pain. Lead encephalopathy is common among children who live near zinc lead smelters—the characteristic symptoms are vomiting, drowsiness and neurological problems.

Due to the chemical analogy of lead with cadmium, bones act as repositories for lead accumulated by the body. Lead poisoning can be cured by treatment with chelating agents which strongly bind lead. Thus the calcium chelate (calcium ethylene diamine tetracetate) is fed to the victim of lead poisoning—lead displaces calcium from the chelate and the resulting lead chelate excreted in the urine.

#### **8.6.6 Toxicity of Mercury**

Industries, associated with mercury hazards, are hat and felt industries, industries manufacturing electrical goods such as fluorescent lamp, electrical switches, mercury batteries, caustic soda and acetic acid producing industries. Agro-industries also use a large number of fungicides containing mercury compounds for seed dressings. Miners are exposed to mercury dust and vapour.

The impact of seed dressing is enormous since it is applied to a large volume of seed, which is subsequently sowed over millions of acres of agricultural fields causing a widespread distribution of mercury compounds. Furthermore, mercury undergoes translocation in plants and animals and then finds its way into human food chain.

Occupational workers, exposed to mercury dust, inorganic salts of mercury and mercury vapour show weakness, fatigue, anorexia, loss of body weight and gastro-intestinal disorders. Non-industrial mercury poisoning results from either ingestion or therapeutic application of mercurials—this leads to acute gastric pain, nausea, blood vomiting, convulsions and in severe cases, unconsciousness and death.

The outbreak of Minamata disease in Japan in 1953–60 brought mercury into limelight. At Minamata Bay in Japan

more than 100 fisherman lost their lives while hundreds were permanently crippled after eating mercury-contaminated fish from the Bay. The sea fish of the Bay picked up mercury from effluent discharged into the Bay by Minamata Chemical Company. By the action of anaerobic bacteria in water, mercury was transformed into methyl mercury, which was actually picked up in magnified amount by the sea fish which in turn magnified it further so that the concentration of methyl mercury was finally increased to 25–100 ppm. This methyl mercury is the most toxic species of mercury which was responsible for the casualties.

Mercury attaches itself to cell membranes and inhibits transport of sugars across the membranes and allows the passage of potassium to the membrane. In case of brain cells, this will result in energy deficiency in the cell and disorders in the transmission of nerve impulses. Babies born to mothers, subjected to methyl mercury poisoning, suffer from brain damages and mental retardation.

#### **8.6.7 Remedial Measures for Mercury Pollution**

The policy of “prevention is better than cure” should be applicable as remedial measures against mercury pollution:

- (i) All chloralkali plants must stop using mercury electrodes and switch to membrane technology;
- (ii) All alkyl mercury pesticides should be banned;
- (iii) All other mercurial pesticides must be restricted to some selected and limited areas.

#### **8.6.8 Toxicity of Some Organic Chemicals (Carcinogens)**

The term “carcinogens” means a group of organic chemicals which cause cancer in animals and human beings. Among these mention may be made of Epichlorohydrin,  $\beta$ -Naphthylamine, Vinyl chloride, Ethylene chloride and Nitrosamine.



### *Epichlorohydrin*

Epichlorohydrin is used as an intermediate for the manufacture of epoxy resins, pharmaceuticals, cleansing agents, etc. It leads to chromosomal aberration and respiratory cancer among workers, exposed to this chemical.

### *β-Naphthylamine (BNA)*

β-Naphthylamine (BNA) is an intermediate compound used in the manufacture of several dyes and anti-oxidants. It enters the environment through the waste effluent stream from manufacturing plants. It causes bladder cancer among workers manufacturing and handling this chemical.

### *Vinyl Chloride*

Vinyl Chloride is used in large amounts for the production of polyvinyl chloride (PVC) and copolymer resins (plastics). PVC resin is used for the production of plastic pipes, electrical appliances, floor coverings, etc.

Vinyl chloride in gaseous form enters the environment both from liquid vinyl chloride and PVC plants. Each cigarette contains 15–17 mg vinyl chloride. Automobile interiors have been found to contain 0.4–1.2 ppm vinyl chloride.

Vinyl chloride leads to liver cancer among occupational workers. Excess mortality has also been reported among them.

### *Ethylene Dichloride*

Ethylene dichloride is used as industrial solvent, grain fumigant and gasoline additive. It causes stomach, spleen and lung cancer.

Besides the above, polycyclic aromatic hydrocarbons (PAH), e.g. benzo- $\alpha$ -pyrene deserve special mention. They commonly occur in urban air (about 20  $\mu\text{g}/\text{m}^3$ ). They originate from pyrolysis of higher paraffins present in fuels and plant

materials. Most of these PAH compounds remain adsorbed on soot particles in air (*see* Soot, Chapter 6). They are well-known carcinogens.

### **Key Terms and Concepts (Glossary)**

*Asbestosis*: A disease of the lungs and respiratory tract by inhalation of fine asbestos particles (silica dust). This can lead to cancer and death.

*Byssinosis*: Cotton dust in cotton and textile mills attacks the workers causing, byssinosis leading to respiratory problems and shortening life span.

*Carcinogens*: A group of organic compounds which cause cancer in animals and human beings. Examples are vinyl chloride, ethylene chloride, polycyclic aromatic hydrocarbons, etc.

*Cholera*: Highly contagious disease, borne by water and caused by the bacteria, vibrio cholera. Outbreaks of cholera have been reported in the past from various parts of India.

*Deadly Dust*: Industrial workers are exposed to dust from various industries and suffer from lung diseases. Such dust from industrial processes is known as deadly dust.

*Hazardous Products*: Industrial products which cause various health hazards and severe diseases are known as hazardous products.

*Hygiene*: Science of health including all factors contributing to healthy living. The sense of hygiene helps man to live in healthy environment.

*Malaria*: A tropical disease spread by mosquito—it originates from dirty environment. It is characterised by recurring high fever associated with shivering and sweating. Malaria kills about 2 million people every year all over the world while about 300 million people suffer from the disease.

*Occupational Hazards:* Various occupations e.g. in mines, factories, commercial firms, agriculture, etc. involve dangers or risks. Workers in these professions are exposed to risks or hazards which are known as occupational hazards. Every year about 2 lakh workers die throughout the world due to occupational diseases while about 10 million workers suffer from various non-fatal injuries.

*Pesticides:* Chemicals which kill pests harmful for agriculture, animals and man. These include insecticides, herbicides, fungicides, etc. The uses of pesticide such as DDT helped in the eradication of malaria and boosted agricultural production. Excessive use of pesticides is harmful for environment.

*Pneumoconiosis:* A chronic respiratory disease affecting the lungs of colliery workers leading to tuberculosis and death.

*Toxicity:* Poisonous effect of some chemicals on biological and physiological systems of man, animals and plants. Toxic elements are arsenic, mercury, etc. and toxic chemicals are DDT and other pesticides.

*Water-borne Diseases:* Diseases caused by polluted water e.g. cholera, dysentery, diarrhoea, etc.

## QUESTIONS

1. List some public health issues arising from environmental pollution.
2. Give an account of hazardous products from (i) fertiliser factories, (ii) thermal power plants and (iii) pesticide factories. What is meant by “Occupational hazards”?
3. Write notes on: (a) Asbestosis (b) Silicosis (c) Byssinosis and (d) Pneumoconiosis.
4. What is meant by “Epidemiology”?
5. Explain the origin of a typical vector-borne disease.
6. Name the parasites responsible for Malaria.

7. Suggest treatment of Malaria. How can the disease be prevented?  
“Malaria was eradicated in the fifties but it staged a comeback in recent years.” Elucidate.
8. Describe symptoms, diagnosis and treatment of a major water-borne disease.
9. What are pesticides? How are they classified? Give examples.
10. Explain the biochemical effects of pesticides on humans. Take the cases of organochlorine and organophosphate pesticides as examples.



---

# Waste Treatment/ Management and Recycling

## 9.1 WASTE TREATMENT

Waste water treatment has already been described under Chapter 5, Section 5.5. Primary and secondary treatment of domestic waste water (municipal waste water) has been discussed. Industrial waste water treatment has also been dealt with.

Disposal of gaseous wastes and their control has been illustrated in Chapter 6. In this chapter only solid waste disposal will be discussed.

## 9.2 WASTE CLASSIFICATION AND DISPOSAL

Wastes can be broadly classified as domestic, trade and industrial. Domestic waste includes garbage from houses and other residential premises. Industrial waste originates from all mineral, manufacturing and processing establishments.

The break-up of annual solid waste production is given below.

Domestic and trade	8.5%
Other industries	15.2%
Thermal power stations	7.3%
Construction	2%
Mining and quarrying	67%

Some typical toxic wastes (liquid/solid) are listed below:

- Tarry liquids;
- Solid tarry matter;
- Sludge from tar distillation;
- Acid tars;
- Waste oil;
- Lubricants;
- Water-kerosene mixtures;
- Waste paint;
- Lacquers;
- Pesticide residues;
- Mercaptans;
- Photographic wastes;
- Plating sludges;
- Leaded petrol sludges;
- Sludges containing copper, zinc, cadmium;  
    nickel, arsenic, etc.
- Cyanide wastes;
- Sulphides, fluorides;
- Alkaloid wastes;
- Aromatic hydrocarbons;
- Chlorophenols;
- $\beta$ -naphthylamine;
- Noxious organic solvents

### 9.2.1 Solid Waste Disposal

The methods of waste disposal depend on the nature of waste. Most solid wastes are dumped on land as soil heaps or as landfill to quarries or mine shafts or as dumps consisting of a wide range of materials. Besides these some wastes are dumped into the seas. The various modes of waste disposal are illustrated in Fig. 9.1.

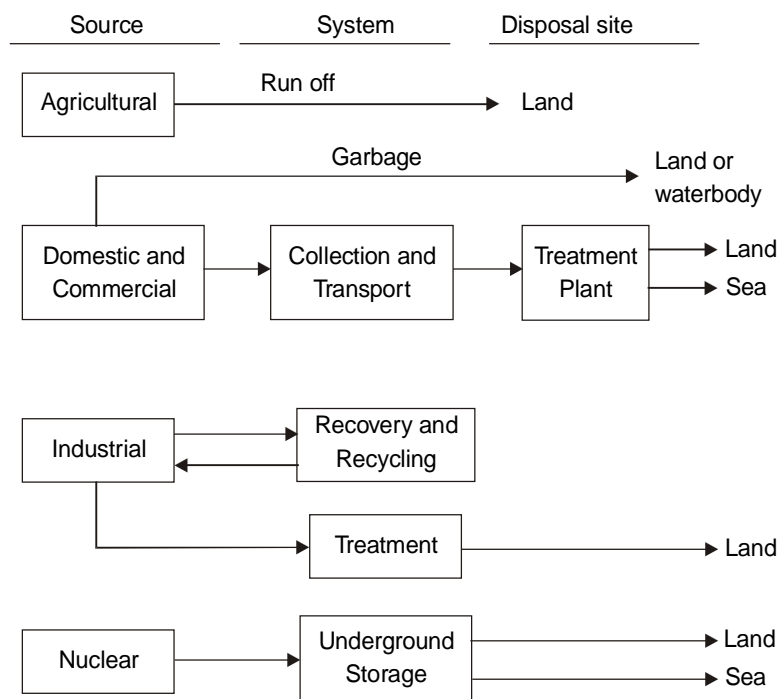

Fig. 9.1 Modes of waste disposal

### 9.2.2 Detoxification of Toxic Wastes

The toxic wastes are converted into less hazardous products by treatment with acids; cyanide containing wastes are decomposed by interaction with oxygen to form carbon dioxide

and nitrogen. The decomposition can also be carried out biologically by means of suitable micro-organisms (bacteria). Sludge from petroleum refineries may be spread on the soil and left to decay into harmless products.

Incineration of toxic wastes is another method for their disposal. However, incinerators need pollution control devices and careful monitoring to make sure that they do not release toxic byproducts into the environment.

### 9.2.3 Land and Ocean Disposal

Radioactive wastes from nuclear power stations are generally fused in glass containers and lowered to the ocean floor. In USA such wastes are sealed in metal drums and buried underground at great depths. But they may leak or be damaged by earthquake and release the wastes into ground water.

Hazardous wastes dumped into soil/ditch have chances of leaking to the ground. A typical case history is that of the *Love Canal* in Niagara Falls, New York, USA. In 1930–53 the canal ditch was the dumpsite for hazardous chemical wastes and municipal wastes. In 1953 the ditch was filled up; it was covered with clay and sold to the city Board of Education which built an elementary school. Some houses were also built. Soon the residents of these houses (300 families) and the school authorities complained of foul odour and illnesses. In 1978 it was found that some 25 toxic organic compounds known as carcinogens, leaked into the basements in the area and dispersed into air. As a result of these findings, the State of New York declared emergency in the area and transferred all the families and the school from the site (Fig. 9.2; p. 177).

## 9.3 NON-HAZARDOUS WASTE MANAGEMENT

Two techniques are available—(i) Landfill and (ii) Incineration.



### 9.3.1 Sanitary Landfill

Miscellaneous refuse materials are those from household, hotels, stores, markets, restaurants, etc. (e.g. food wastes, vegetable and animal wastes, paper, cardboard, wood, boxes, rubber, leather, plastics, tin cans, crockery glass, metals, etc.), ashes (from fires used for cooking, heating buildings, etc.), dead animals, industries and agricultural fields, etc. In the developed countries, e.g. USA it is a common practice for each household to burn the bulk of waste in a backyard incinerator. Mainly food scraps, bottles and combustible articles are contained in packets for collection by municipality. The percentage of paper, rubber, leather, plastics, metals and glass increases considerably with increasing industrialisation in developed countries compared to developing countries because of wide application of these materials in their daily lives.

Most of the solid waste is dumped on land in heaps in uncontrolled manner in developing countries. Some waste is used for landfilling in abandoned quarries or mines. The developed countries prefer the second method, viz. incineration (*see* next section). Industrial wastes are treated in treatment plants and valuable materials recycled. In other cases, the volume of the waste is reduced by pulverisation (33 per cent) or by incineration.

For sanitary landfill, the following principles should be followed:

- (i) solid wastes should be deposited in a regulated manner, preferably in gravel pit;
- (ii) solid wastes should be spread in thin layers with ground cover of at least 15 cm;
- (iii) all factors likely to contribute to water pollution should be eliminated;
- (iv) the wastes should not be burnt openly.

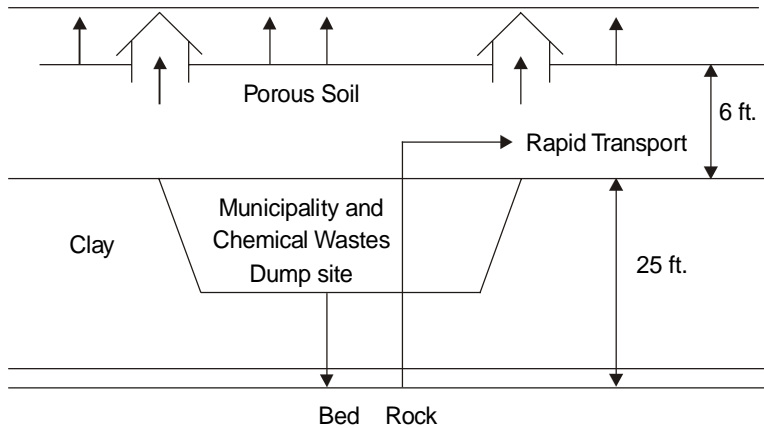

**Fig. 9.2** Transport of toxic organic chemicals from Love Canal dumpsite into adjoining areas

In the man-made gravel pit fine grained soil is useful in containing undesirable gas and water movements outside the landfill area. With increase in urbanisation and expansion of cities beyond the periphery, land suitable for landfill becomes more and more scarce. In such cases planned sanitary landfill, backed by modern solid waste management, can provide the community with better environmental management.

### 9.3.2 Composting and Municipal Waste Composting Projects

This is biological process where fresh organic wastes are allowed to be decomposed into humus-like substances. The process is conducted by a complete automatic system which consists of several steps: (1) The crude refuse is dumped into a container or to a belt conveyor. (2) Iron or metallic particles are removed by a magnetic separator. (3) The material is then transferred in a wet condition to a rotatory cylinder, analogous to a rotatory drier. The cylinder rotates slowly on large tyres and the wastes move from one end to the other. They are thoroughly mixed and pulverised by abrasion. Air is introduced

at low pressure throughout the length of the cylinder. Here aerobic micro-organisms ensure rapid decomposition of the wastes under aerobic conditions.

In several parts of India compost plants are in operations, e.g. in Ahmedabad, Calcutta, Mumbai, Chennai, Delhi, Pune, and Hyderabad. The minimum plant capacity is 100 tons per day. The Government encourages feeding of compost plants by municipal wastes as raw materials. Compost has been used by Indian Agricultural Research Institute (IARI), New Delhi to develop strains of blue-green algae for application to rice fields with a view to nitrogen fixation. An appropriate technology is being developed by IARI to produce blue-green algae-coated granulated compost.

### 9.3.3 Incineration

This is the preferred technique for waste management, particularly in the developed countries. It reduces the waste volume by 90 per cent at 900–1000° C. Incineration offers environment-friendly technique—free from corrosion, emission of offensive odours and also free from bacteria and wet organic matter which gives off foul odours and gases. The waste heat from incineration can be utilised for supplementing electricity generation for domestic heating, etc. The only drawback is that the technique is costly at present requiring expensive equipment.

Two types of incinerators are used for unsorted wastes. The batch type plant is manually stoked and has a relatively small rated capacity. The operation is intermittent and lacks uniform burning temperature. This leads to incomplete combustion and yields an unstable residue. These units are not suitable for large cities. The continuous feed plant has larger storage bins, automatic feed hoppers and a variety of moving gates and ash removal systems. The unit maintains a uniform combustion range, can be fitted with pollution control devices and yields stable residue.

Japan since 1970 and Germany since 1990 developed recycling technology of plastic wastes. The latter was subjected to incineration and gasification—the gaseous products were converted to chemical raw materials (water gas, i.e. carbon monoxide and hydrogen mixture which can be utilised for production of methanol) and the heat generated used for electrical generation units or for domestic heating. The waste volume shrinks to 20 per cent and carbon dioxide released to the atmosphere is minimum so that the technique offers good recycling.

#### **9.4 OCEAN DUMPING**

In the developed countries such as USA about 50–75 million tons of waste are dumped every year within 200–300 km. of ocean shore. In earlier years waste dumped into the ocean 100 km. from the shore did little damage. But over the years industrial wastes and domestic wastes have become more toxic.

Industrial wastes contain numerous toxins and sewage sludge also contains lot of toxic metals. Disease-causing organisms and heavy metals have destroyed many coastal fisheries. Anti-dumping Act (1972) has been violated and many metropolitan cities—New York, Tokyo, etc.—continue to dump sewage into the ocean. It has been the practice in all countries including India to throw radioactive wastes into the oceans and high seas.

#### **9.5 SOLID WASTE MANAGEMENT BY BIOTECHNOLOGY**

According to biologists, bacteria and fungi are capable of decomposing organic waste and it may be possible to recover resources by this process. Natural micro-organisms can do this job—it is also possible to produce such micro-organisms

by genetic engineering. The promising development is the isolation of bacteria which can break down polychlorinated biphenyls (PCBs).

New biodegradable plastics are important step towards solving our solid waste problems in respect of plastic wastes. On exposure to micro-organisms which metabolise glucose, biodegradable polymers break down into short carbon chains that decomposers can metabolise. Photodegradable plastics have been developed, which break down on exposure to sunlight.

### **Key Terms and Concepts (Glossary)**

*Biotechnology:* The technology of using micro-organisms—bacteria, fungi, etc. for decomposition of organic matter (waste) is known as biotechnology. This is useful for disposing of solid waste and recovering valuable components. Fungi have been cultivated that can destroy and disperse toxic element e.g. selenium from soil. Photodegradable plastics have been developed which break down under exposure to sunlight.

*Composting:* A biological method of disposal of solid wastes in which fresh organic wastes are converted by decomposition into stable humus-like substance. Aerobic micro-organisms ensure rapid decomposition of the wastes.

*Detoxification:* Method of disposal of toxic (poisonous) waste by conversion into substances which are not hazardous. Chemical (addition of acids) or biological (use of micro-organisms) methods can be employed. The latter are commonly used.

*Incineration:* Process of burning solid wastes to ashes in a special furnace (incinerator).

*Sanitary Landfill:* Disposal of solid waste by dumping in a gravel pit and covering with soil.

*Waste Treatment:* Solid, liquid and gaseous wastes are disposed of by various processes—these fall under the category of waste

treatment. The processes include separation, recycling and recovery of valuable materials and disposal of wastes.

## QUESTIONS

1. How would you classify wastes? Give a list of typical toxic wastes.
2. Give an outline of the modes of solid waste disposal.
3. What are hazardous wastes? How can you provide for their detoxification?
4. Comment on land and ocean disposal of hazardous wastes.
5. Give an account of the Love Canal Dumpsite incident.
6. Classify the main categories of the solid wastes and characterise the contents and sources.
7. How do you propose solid waste management? Discuss the merits and demerits of each method proposed by you.
8. Write short notes on:
  - (a) Sanitary landfill method for waste disposal,
  - (b) Incineration method for waste disposal,
  - (c) Municipal waste composting in India,
  - (d) Biotechnological approach to solid waste disposal.



---

# Environmental Policies

## 10.1 ENVIRONMENTAL INSTRUMENTS AND INSTITUTIONS

The Central and State Governments own, control and develop almost all the country's forests, dams, major irrigation systems, power stations, railways, ports, roads, mines and many industries. The Government is not just the protector of the country's environment but it also has the role of destroyer if it neglects its responsibility. The Government has immense responsibility for sustaining environmental conscience.

India's active interest in environment was initiated in 1972 when the then Prime Minister (late Smt. Indira Gandhi) attended the United Nations Conference on Human Environment. A National Committee on Environmental Planning and Co-ordination (NCEOC) was created to act as the apex advisory body in the Department of Science and Technology (DST). The Fourth Five Year Plan (1969–74) mentioned the need for comprehensive recognition of environmental issues in any developmental plan. The successor of NCEPC was the Department of Environment (DOEn) in 1980 within the Ministry of Science and Technology, headed by the Prime Minister. The DOEn is the nodal agency to ensure environmental protection, to conduct environmental impact

studies of development projects and have the administrative responsibility for pollution monitoring and control. In 1985 the topics of wild life and forests were added to the list and a new Ministry of Environment and Forests was created which remained under the charge of the Prime Minister.

The assignments of the Ministry of Environment and Forests are:

- (i) Environmental Laws and Policies
- (ii) Environmental Monitoring and Control
- (iii) Survey of Conservation of Natural Resources
- (iv) Management of Forests and Conservation of Wild Life
- (v) Environmental Education, Awareness and Information
- (vi) International Co-operation

The Ministry of Environment and Forests is the Government's main instrument for generating eco-consciousness within the Government and outside. But with passage of time, it has been found to be bogged down in bureaucracy and to fail to respond to environmental issues. The Ministry has three major units:

- (a) Department of Environment, Forests and Wild Life
- (b) National Wastelands Development Board (NWDB) and
- (c) Ganga Project Directorate

The State Governments also set up their own Ministries of Environment. The Central Prevention and Control of Pollution Board attends to water and air pollution problems at national level while their counterpart State Boards are in charge of their respective State issues.

## **10.2 ENVIRONMENTAL POLICIES**

The Government's environmental policy focusses on the areas:



1. Conservation of natural resources by direct action such as declaration of Reserved Forests, Biosphere, Wetlands, Mangroves and protection of endangered species;
2. Check further degradation of land and water through Wasteland Management and Restoration of river water quality programmes;
3. Monitoring development through Environmental Impact Assessment Studies of major project proposals; and
4. Penal measures for industries which violate Pollution Control Act.

### **10.2.1 Forests**

The policy for conservation of natural resources mainly focusses on the policy for conservation of forests. The latter has undergone various processes of legislation over the last two centuries. Some forests have been declared as Reserve Forests, the first being the Corbett National Park (1936). The National Forest Policy was framed in 1988 for forest management in view of the rapidly vanishing forests which now stand at about 15 per cent forest cover. The Forest Policy aims at 33 per cent forest cover. In the hilly regions most of the major rivers originate and the ecosystem is fragile—the new Policy targets at 67 per cent of land under forest cover, encourages massive afforestation and prohibits deforestation. The role of tribals living in the forests and on forest products has been recognised and their symbiotic (i.e. intimate association) relationship with forests since ancient times has been respected.

### **10.2.2 Biosphere Reserves**

In different regions of the country several Biosphere Reserves have been declared for conservation of different ecosystems. At present 13 Biosphere Reserves have been recommended.

### 10.2.3 Flora and Wild Life

The total area under mangroves in India is about 6750 sq. km. which is about 7 per cent of world's mangroves. Among these the Sunderbans of West Bengal has the largest area under mangroves, 4200 sq. km., the next being Andaman and Nicobar islands, 1190 sq. km. together accounting for 80 per cent of the total mangroves in the country. The mangroves have suffered severe deforestation, which must be checked.

India is rich in biodiversity with about 75,000 species of animals and 45,000 species of plants. The fauna (animals) include 340 species of mammals, 1200 species of birds, 420 species of reptiles, 140 species of amphibians, 2000 of fishes., 4000 of molluscs and 5000 of insects besides other invertebrates (those without backbones/spines). The flora include 15000 species of flowering plants, 5000 algae, 1600 lichens, 20,000 fungi, 2700 bryophytes, etc. Rich biodiversity is also observed in wetlands and mangroves which serve as treasurehouses of genetic resources and also as active protective systems. There is cause for alarm when we notice overexploitation of biodiversity and continued habitat (shelter) destruction (deforestation). Extinction of species is on the increase—everyday we are losing one animal and one plant species. Already a large number of plant and animal species are in the list of the endangered species.

## 10.3 ENVIRONMENTAL LAWS/ACTS

There are more than 200 Central and State Laws to-day that can be interpreted one way or another to protect the environment. Only the more important Laws/Acts are tabulated below.

### 10.3.1 Forests

1927, Indian Forest Act—Forests were classified as

- Reserve Forest

- Protected Forest
- Village Forest
- Restriction on hunting and authorised establishments of Sanctuaries.

1976, 42nd Amendment to the Constitution of India—Forests were transferred from State list to the Concurrent list (i.e. all India Basis).

1980, Indian Forest Act—National Forest Policy

- Prohibits State Government's for declaring any portion of forest as non-reserved without approval of Central Government.
- Prohibits State Government for allotting any forest land or any portion thereof for any non-forest purpose.

1988, Indian Forest Act—Welfare of forest-dwellers is the major objective

- Prohibits lease of forest land to anybody other than Government.
- Conservation, planting and increase of forest cover to an average of 30 per cent across the country.

### 10.3.2 Wildlife

1927, Indian Forest Act—Restriction on hunting

- establishment of sanctuaries.

1936, Corbett National Park—First wild life National Park Act

- establishment of Sanctuary—Tiger reserve.

1972, Wildlife Protection Act—Action Plan for wild life objectives

- management of protected areas and habitat,
- rehabilitation of endangered and threatened species,
- National Conservation Strategy,
- collaboration with voluntary bodies and NGOs.

### 10.3.3 Water

1927, Indian Forest Act—Prohibits poisoning of water in forests

1948, Indian Factories Act—Restrictions on discharge of effluents into water bodies

1974, Water (Prevention and control of Pollution Act)—Setting up of Pollution Control Boards at Centre and States

- Industries required to submit discharge data for effluents,
- Penal provision for non-compliance.

1986, Environment Protection Act (EPA) (Act introduced in the wake of Bhopal Disaster, 1984)—Protection and improvement of human environment and prevention of hazards to humans, plants, animals and property

The Environment Protection Act (EPA) empowered the Central Government to issue orders for closing down industries for non-compliance, imposing on them heavy penalty, etc.

Under the provision of EPA, every State set up “Green Bench” courts to attend to Public Interest Litigation (PIL) cases concerning environmental hazards affecting the quality of life of the citizen. The “Green Bench” courts have been empowered to settle the cases quickly and provide legal redress to the citizens.

### 10.3.4 Air

1948, Indian Factories Act—Protection to workers against hazardous processes.

1981, Air (Prevention and Control of Pollution Act) Act—Ambient air quality specified.

- monitoring stations established.

1987, Air Act—Empowers Government to close down polluting industries and stop their supply line of water and electricity.

1989, Motor Vehicles Act—Emission standards of carbon monoxide and hydrocarbons specified.

### **10.3.5 Environmental Impact Assessment (EIA)**

Analysis of any possible change in the environmental quality, adverse or beneficial, caused by a developmental project of Government or private company is known as Environmental Impact Assessment (EIA). As a matter of Government policy, it is compulsory for any enterprise (Government/private) to include EIA in the planning stage of any developmental project and submit it to the Central Government for clearance. All major and minor irrigation projects and all highly polluting industries are subjected to EIA for their initiation.

## **10.4 ENVIRONMENTAL MOVEMENTS**

### **10.4.1 Chipko Movement**

In 1973 the Chipko Movement (Chipko means to hug or stick to) was launched by Chandi Prasad Bhatt and Sunder Lal Bahuguna against large scale felling of trees by timber contractors in the Uttarakhand hills (UP). The starting point was Chamoli district of Garhwal region in UP. A unique feature was that local hill women from villages were organised and made aware of the ecological threat in the hills. They took active part in the campaign—they embraced trees when the timber contractors reached and compelled them to leave. This novel campaign of saving hill forests and greenery soon spread all along the hill region and to Karnataka in the South in 1983 where it was named “Appiko”.

In course of time the Chipko movement crossed geographical boundaries and observed as Chipko Day at New York, USA on April 29, 1983. A group of school children assembled and hugged a big tree in Union Square Park, followed by some adults.

### 10.4.2 Silent Valley Movement

Silent Valley occupies an area of 8950 hectares at an altitude of 3000 ft. in Palaghat district, Kerala. It is surrounded by the Nilgiri forests to the north and Attappadi forests to the east—together they comprise 40,000 hectares of pristine (i.e. primitive) forest. This tropical rain forest in the Western Ghat is a precious reservoir of genetic diversity which has not been fully exploited—here plant species and other forms of life have survived for centuries in the forest. It is this gene pool to which man has to turn in future for new materials for agriculture, for life-saving drugs, etc.

The Kerala State Government decided to construct a dam in the Silent Valley for generation of 120 MW (megawatts) of electricity in 1976 at an estimated cost of Rs 25 crores (revised in 1984 to Rs 51 crores). The proposed dam would store 270 million cubic feet water in a reservoir spreading over 700 hectares. In order to save the Silent Valley from destruction in the process of Government dam project, the Kerala based NGO, Kerala Sastra Sahitya Parisad (KSSP) launched the Silent Valley Movement, supported by students, teachers and people of Kerala.

Soon the apex policy making bodies NCEPC, DOEn and Switzerland-based IUCN (International Union for Conservation of Nature and Natural Resources) strongly supported the cause of Silent Valley. Finally the Prime Minister (Indira Gandhi) in 1983 accepted the recommendation of top scientists and environmentalists and declared the Silent Valley as the Biosphere Reserve by cancelling the hydel project proposal of the State Government. This is the success story of an environmental movement for protection of an important biosphere reserve.

### 10.4.3 Narmada Dam

Narmada is the largest west flowing river arising from the Amar Kantaka Plateau in Shahdol district of Madhya Pradesh

and travels 1300 km. draining 9.88 million hectares between the Vindhya and Satpura ranges. This vast basin—average annual flow is 41 billion cubic metres—is mostly untapped because of inter-state (Gujrat, MP) water disputes. The MP Government undertook a gigantic plan—Narmada Basin Development Programme—which involves construction of 31 large dams for Narmada and its tributaries, 450 medium-sized projects and several thousand minor structures at a cost of about Rs 25,000 crores. The benefits were projected—several million hectares of land irrigated; water supply to thousands of industries; several thousand megawatts of power, etc.

But according to environmentalists and environment action groups massive damming of the Narmada river could be a blueprint for disaster. The basin is one of the most densely forested in India. The project would imply displacement of over 1 million people, mostly tribals, submerging of over 1000 villages and over 50,000 hectares of agricultural land and also loss of forests in the region. The damage to environment and people far outweighs the projected benefits. The environmental action groups, led by the environmentalist, Smt. Medha Patkar, organised sustained movement to stall the projects of Sardar Sarobar and Narmada Sagar dams and partly succeeded.

## 10.5 ENVIRONMENTAL ETHICS AND AWARENESS

India has a rich tradition of environmental ethics since the Vedic era some 5000 years ago. The spirit of conservation ethics was inherent in our history, culture, religion and philosophy. The message of *Isho-Upanishad* underscores the philosophy:

**“The Universe has been created and nurtured by God. Man can enjoy the bounties of Nature by giving up greed.”**

The sublime concept of living harmoniously with Nature was practised by our *seers (rishis)*; their *Tapovan ashramas* (forest

hermitages for meditation) and *gurukul education* (teacher-based education) are models for all ages. The compassion for animates and inanimates is the keynote of Indian culture. Buddha and Mahavira preached *non-violence* (“Ahimsa Paramo Dharma”) 2500 years ago, which was also introduced in the 20th Century by Mahatma Gandhi. The Noble-laureate World Poet, Tagore presented to the nation the concepts and practices of Vriksharopana (Tree Plantation) ceremony in 1927 and Ashrama Model Open Air School at Santiniketan (1902), that is, long before the world woke up to the alarming environmental issues.

But we failed to sustain our heritage of environmental ethics and lead the world in this matter. We were swept by the Western world approach of establishing supremacy over Nature and exploiting the natural resources, instead of utilising them as per our old tradition. Again our concern for environment started only two decades after the Western world took note of it and worked seriously for handling the environmental issues.

### 10.5.1 Environmental Awareness

The International Conference on Environmental Education in 1981 stressed the need for environmental education at all levels to help arouse social and community consciousness about the environment. The Bhopal disaster of 1984, the worst environmental disaster in history, focussed very bluntly on the need of environmental education and awareness in India.

The disaster took toll of 10,000 lives in one week; 1000 people turned blind and more than 1 lakh people continue to suffer from various disorders. This tragedy was possible in third world country like India due to negligence and lack of awareness at all levels—Central Government, State Government, industry, public and hospital doctors.

In this context it is important to note the Chinese proverb relating to education:



**“If you plan for one year, plant rice;  
If you plan for ten years, plant trees;  
But if you plan for 100 years, educate the  
people.”**

So people’s education is important in the long-term interest of a country.

People must be made aware of the present state of environment and crisis and also the remedies. Both formal and non-formal education should be the instruments of education and awareness. Formal education (school/college/university) is meant for students in the educational system. Non-formal education (adult education, literacy mission, etc.) is meant for those who are outside our educational institutions, that is, the majority of Indian population. In other words, the basic or elementary concepts of environment should reach out to the entire population all over the country. The University Grants Commission recently urged the Universities to introduce the syllabus on Environment for under-graduates in all streams (Arts/Science/Commerce). The present book has been designed as a text-book for this purpose.

Environmental ethics can be cultivated from now on so that it can be part of the lifestyle of the present and future generations. The following guidelines are meant for the government/institutions and individuals in their daily lives:

**For the Government(National Policy)[Action Plan]**

1. Reduce population growth rate by 30 per cent (from 3.0 to less than 2.0 per cent) over the next five years.
2. Reduce livestock population by 30 per cent over the next five years in order to cut down methane (green house gas) emissions.
3. Shift from coal-fired thermal power stations to gas-fired power stations, solar energy, wind power and hydel power as alternative sources of energy.

4. Impose heavy penalties for motor vehicles exceeding emission levels.
5. Introduce CFC-substitutes in all air-conditioners and refrigerators to reduce ozone hole.

### **For the Individuals and Groups [Actions Plan]**

1. Keep your home and surrounding areas clean and also working places (offices/institutions) clean
2. Enforce “No Smoking” in as many public places (offices/institutions/banks/post offices/public transports/public halls, etc.) as possible besides own homes.
3. Promote literacy and environmental campaigns among the masses
4. Organise environmental brigades in every block consisting of young and old people including girls and women for protection and conservation of environment.
5. In critical situations where environment is on the point being destroyed, organise environmental movement along the lines of the Chipko and Silent Valley Movements involving teachers, students and people.
6. Let us take the solemn pledge in our day-to-day life that we shall do our best to make this world a better place to live in for our next and future generations.

### **10.5.2 Non-Government Organisations (NGOs)**

These play important roles in environmental awareness and education. Out of about 200 NGOs, 130 are engaged in these areas, 50 in Nature conservation, 50 in Pollution Control, 45 in Afforestation and Social Forestry, 15 in Rural Development and 10 in Eco-development. Most of these are academically oriented activities. In critical situations they also launch environmental movements. Among the pioneer NGOs, mention should be made of Kerala Sastra Sahitya Parisad (KSSP) which

piloted the Silent Valley Movement and successfully stalled the State Government hydel project.

### **Key Terms and Concepts (Glossary)**

*Biosphere Reserves:* Ecosystems containing valuable species (plants and animals) which require conservation or protection are identified as Biosphere Reserves. The importance of Biosphere Reserves lies in the maintenance of the gene pools of the living species. Twelve Biosphere Reserves have been identified by the National Man and Biosphere Committee (MAB) e.g. Nilgiris (Tamil Nadu, Kerala), Sunderbans (West Bengal), etc.

*Chipko Movement:* Chipko means to hug or stick to. The movement was conducted by hill women of U.P. (Garhwal region) against deforestation in the hills by timber contractors and soon became popular. It prevented large scale deforestation in Tehri-Garhwal region. The State Government was compelled to prohibit tree-felling in the region.

*Environmental Awareness:* For better understanding of the environmental issues of the present age it is necessary to arouse social and community consciousness at all levels. This emphasizes the need of environmental awareness.

*Environmental Ethics:* The moral principles and practices of environmental knowledge and conservation.

*Narmada Dam Movement:* Construction of dams for Narmada river and its tributaries was opposed by environmental action groups led by Medha Patkar. The Project would displace about 1 million people and involve loss of forests and agricultural lands.

*Silent Valley Movement:* Movement organised by Kerala Non-Government Organisation against proposed hydroelectric project of the State Government in the Silent Valley. The movement finally succeeded in stalling the hydel project and

retaining the Silent Valley as an important bioserve containing precious gene pool.

## QUESTIONS

1. Give a brief account of the Environmental Policies of the Government of India relating to (i) Forests, (ii) Biosphere Reserve, (iii) Flora and (iv) Wild Life.
2. State the Environmental Laws relating to:
  - (a) Forests
  - (b) Wild Life
  - (c) Water, and
  - (d) Air
3. Explain the importance of Environmental Impact Assessment (EIA).
4. Give short notes on:
  - (a) Chipko Movement
  - (b) Silent Valley Movement
5. Discuss the importance of Environmental Awareness in our National Policy.
6. Elucidate: “India had rich heritage in environmental ethics. Yet we failed to lead the world in this area and we got the clue in environmental consciousness from the West only in the late seventies.”



---

## Feedback Exercise (Objective Test)

Put a tick mark (✓) against the correct answer/answers in the boxes given. There may be more than one correct answer—both should be marked. *This feedback exercise will help the students to test their understanding of the subject matter of this book which in turn will sustain their interest in environmental science.*

1. Environment means

- (a) a beautiful landscape
- (b) industrial production
- (c) sum total of all conditions that affect the life and development of all organisms on earth

2. Environmental Studies involve studies of

- (a) evolution of life
- (b) all aspects of human environment
- (c) nitrogen cycle

---

Model answers to Questions 1–5 above are given.

3. The killer in Bhopal Disaster was
- (a) methyl isocyanate
  - (b) carbaryl
  - (c) accidental fire in the factory
4. The quality of environment has steadily suffered due to
- (a) man-made activities
  - (b) air-, water-, soil- and food-pollution
  - (c) public awareness
5. Environmental degradation has been due to
- (a) poverty of the developing countries
  - (b) over-consumption of earth's resources by the developed countries
  - (c) poor quality of life
6. The earth was born
- (a) 6.0 billion years ago
  - (b) 4.5 billion years ago
  - (c) 10,000 years ago
7. The first living form (blue-green algae) appeared on earth
- (a) 3.5 billion years ago
  - (b) 6.0 billion years ago
  - (c) 5.0 billion years ago
8. Soil has an important role as it
- (a) gives us space for building houses
  - (b) produces food for us and animals
  - (c) provides highways for traffic
9. Soil, suitable for agriculture, consists of
- (a) micro-organisms only

- (b) rock powder and water
- (c) 5 per cent organic and 95 per cent inorganic matter
- 10. Biosphere means
  - (a) the earth's crust only
  - (b) the earth's crust, air, water and all living species
  - (c) micro-organisms only
- 11. The earth swings back and forth between hot and cold periods
  - (a) with the rise and fall of carbon dioxide concentration
  - (b) with change in ocean currents
  - (c) with increased deforestation
- 12. We get our supply and reserves of fresh water
  - (a) from hydrological cycle
  - (b) from carbon cycle
  - (c) from snowfall
- 13. The source of atmospheric oxygen is
  - (a) the nitrogen cycle
  - (b) photosynthesis by green plants
  - (c) exchange of oxygen among the environmental segments
- 14. The major reservoir of carbon (carbon dioxide) is
  - (a) the ocean beds
  - (b) the atmosphere
  - (c) plants and animals
- 15. Forests are important
  - (a) for life support systems

- (b) renewable resources
- (c) for animals only
16. India has been losing
- (a) very little forests each year
- (b) 1.3 million hectares of forests each year
- (c) 100 million hectares of forests each year
17. The main causes for deforestation are
- (a) tribal people
- (b) increasing human and livestock population
- (c) timber business
18. The aim of social forestry is to meet the demand for
- (a) firewood and fodder among rural people
- (b) furniture for urban people
- (c) removing pressure on natural forests
19. Biodiversity involves
- (a) forests only
- (b) the living natural resources (plants, animals, micro-organisms)
- (c) human beings
20. Extinction of species is
- (a) part of natural extinction
- (b) natural extinction accelerated by man-made extinction
- (c) due to natural disasters
21. The P-Triangle is composed of
- (a) biodiversity
- (b) population, poverty and pollution
- (c) poverty, flood and drought



22. Indian population doubled
- (a) between 1901 and 1930
  - (b) between 1950 and 1981
  - (c) between 1941 and 1961
23. The countries with 1-billion + population are
- (a) China and India
  - (b) USA and Canada
  - (c) France and Germany
24. Population explosion occurs when
- (a) population increases at a slow rate
  - (b) population size exceeds the carrying capacity
  - (c) population matches the natural resources
25. Population stabilisation is essential for
- (a) agriculture
  - (b) economic growth
  - (c) sustainable development
26. Human Development Index (HDI) is based on the parameters
- (a) life span, literacy and standard of living
  - (b) growth of population and industry
  - (c) income and education of an adult
27. In India 50 per cent population
- (a) have good standard of living
  - (b) live below the poverty line
  - (c) have no access to safe drinking water
28. India loses top soil
- (a) 5 billion tons a year
  - (b) 1 billion ton a year
  - (c) 25 billion tons a year

29. Soil erosion or loss of top soil is caused by
- (a) agriculture
  - (b) deforestation
  - (c) drought and flood
30. Fresh water available for our use is
- (a) less than 5 per cent of total water resources
  - (b) more than 10 per cent of total water resources
  - (c) less than 1 per cent of total water resources
31. Ocean water, vast water resource (97 per cent), is
- (a) good for agriculture
  - (b) unfit for human consumption
  - (c) useful for coastal vegetation
32. Compared to sea water and lake water, ground water contains
- (a) same mineral salts and nitrate and bicarbonate
  - (b) less mineral salts, nitrate and bicarbonate
  - (c) more mineral salts, nitrate and bicarbonate
33. The symptoms of polluted water are:
- (a) no change in physical appearance
  - (b) no external matter on the surface
  - (c) foul smell, bad taste, oil and grease and dead fish floating on the surface
34. Organic pollutants in water include
- (a) soap and detergents
  - (b) mine drainage (acid)
  - (c) domestic sewage, pesticides, paper mill and tannery wastes

35. Eutrophication results from
- (a) Agricultural run-off and domestic sewage input
  - (b) industrial effluent
  - (c) vehicular exhausts
36. Pesticide residues in crops enter the human bodies through
- (a) birds and insects
  - (b) human food chain
  - (c) animals only
37. Thermal pollution originates from discharge of waste water from
- (a) steel plant
  - (b) nuclear power plant
  - (c) thermal power plant
38. Arsenic contamination of ground water arises from
- (a) excessive pumping of ground water by shallow tube wells for irrigation
  - (b) seepage of surface water
  - (c) leaching of arsenopyrite mineral into ground water
39. Arsenic poisoning from drinking water leads to
- (a) loss of hair, brittle nails, gangrene and cancer
  - (b) diarrhoea, dysentery, etc.
  - (c) pneumonia, typhoid, etc.
40. The Ganga river is heavily polluted at
- (a) Rishikesh and Haridwar
  - (b) Kanpur, Varanasi and Calcutta
  - (c) Patna and Allahabad

41. The Ganga pollution is due to dumping of
- (a) domestic and industrial sewage's
  - (b) waste from forests
  - (c) food wastes
42. The Ganga Action Plan is based on
- (a) mixing with rain water
  - (b) preventing input of domestic and industrial wastes
  - (c) recycling of water after waste treatment
43. Primary and secondary waste water treatment is based on
- (a) screening of solid matter only
  - (b) injecting air stream only
  - (c) screening, sedimentation, aerobic digestion and sedimentation
44. The important water quality parameters are:
- (a) Calcium, magnesium, iron
  - (b) Lead, zinc, mercury
  - (c) Dissolved oxygen chemical oxygen demand, chloride and arsenic
45. Desalinization of sea water means
- (a) removal of salts from sea water
  - (b) dumping of oil into sea water
  - (c) removal of suspended solids from sea water
46. Water treatment for drinking water supply requires
- (a) filtration through sand bed
  - (b) disinfection by chlorination to kill viruses, bacteria, etc.
  - (c) sedimentation

47. The major components of the atmosphere are
- (a) rare gases
  - (b) carbon dioxide and argon
  - (c) nitrogen, oxygen and water vapour
48. The important chemical species in the Troposphere are
- (a) oxygen, nitric oxide
  - (b) nitrogen, oxygen, carbon dioxide and water vapour
  - (c) sulphur dioxide, carbon monoxide
49. The life-saving gas in the atmosphere is
- (a) ozone in the stratosphere
  - (b) water vapour in the Troposphere
  - (c) oxygen (charged) in the Mesosphere
50. Global warming is
- (a) an ocean phenomenon
  - (b) atmospheric phenomenon
  - (c) soil phenomenon
51. The Greenhouse effect is due to
- (a) carbon dioxide, water vapour, methane and chlorofluorocarbons
  - (b) nitrogen oxides
  - (c) sulphur oxides
52. The Greenhouse Effect may cause global disasters:
- (a) by favouring forest fires
  - (b) by increasing the frequencies of cyclones
  - (c) by affecting agricultural production, sea food production and raising the sea levels due to melting of polar ice caps

53. The protective shield for life on earth is
- (a) carbon dioxide
  - (b) oxygen
  - (c) ozone
54. Ozone hole is formed by interaction of ozone with
- (a) hydrocarbons
  - (b) chlorofluorocarbons and nitric oxide
  - (c) carbon dioxide
55. El Nino starts from
- (a) Mediterranean coast
  - (b) Chinese coast
  - (c) South American coast
56. Automobile exhausts consist of
- (a) hydrocarbons, carbon monoxide and nitric oxide
  - (b) carbon, zinc and lead vapour
  - (c) sulphur dioxide
57. Auto emissions are controlled by
- (a) using oxygen stream in the exhaust pipes of automobiles
  - (b) using catalytic converters in the engines
  - (c) replacing petrol/diesel by alcohol
58. Photochemical smog arises from
- (a) ozone and methane in presence of sunlight
  - (b) carbon monoxide and sulphur dioxide
  - (c) photochemical reactions of hydrocarbons, ozone, carbon monoxide and nitrogen oxides

59. Primary air pollutants are
- (a) oxygen nitrogen and water vapour
  - (b) carbon monoxide, nitrogen oxides, sulphur oxides, hydrocarbons and particulates
  - (c) carbon dioxide, sulphur dioxide and ozone
60. Acid rain consists of
- (a) acetic acid and phosphoric acid
  - (b) acetic and phosphoric acids
  - (c) hydrogen chloride, nitric and sulphuric acids
61. Acid rain originates from
- (a) Steel plants
  - (b) thermal power plants
  - (c) nuclear reactors
62. Fine particles (0.01–1.0  $\mu$  size) cause
- (a) asthma, bronchitis, tuberculosis
  - (b) dysentery and diarrhoea
  - (c) typhoid
63. The source of soot particles in air is
- (a) burning of paper
  - (b) combustion of fuel
  - (c) evaporation of water from seas
64. Particulate emissions from gas streams can be removed by
- (a) lightning discharge in air
  - (b) electrostatic precipitator
  - (c) air jet
65. Temperature inversion occurs when
- (a) warm air moves above a cold air mass
  - (b) there is rainfall
  - (c) drought condition prevails

66. Meteorology of the earth is affected by
- (a) natural disasters
  - (b) human activities
  - (c) the earth's rotation
67. Fossil fuel means
- (a) hydroelectricity
  - (b) coal, petroleum and diesel
  - (c) paper and wood
68. Conventional energy resources are
- (a) solar energy
  - (b) Tidal wave energy
  - (c) fossil fuel, wood, natural gas, hydroelectricity and nuclear energy
69. The most abundant energy resource is
- (a) coal
  - (b) solar energy
  - (c) diesel
70. Nuclear power is produced from
- (a) petroleum combustion
  - (b) wood combustion
  - (c) nuclear fission
71. The major renewable natural energy resource is
- (a) coal
  - (b) wood
  - (c) nuclear fuel
72. Sunlight may be converted into electricity through
- (a) photovoltaic cell
  - (b) galvanic cell
  - (c) carbon electrodes



73. Solar energy-based equipments are
- (a) diesel engine
  - (b) solar cooker, solar heater, solar pump, etc.
  - (c) tube well pump
74. The clean pollution-free energy resource is
- (a) petroleum and diesel
  - (b) coal
  - (c) solar energy
75. Hazardous chemicals cause
- (a) no harm to human bodies
  - (b) little harm to animals
  - (c) metabolic disorders in human bodies
76. Industries producing toxic wastes are
- (a) pharmaceuticals
  - (b) fertilisers
  - (c) pesticides
77. Arsenic
- (a) does not affect our health
  - (b) damages liver, kidney, skin, etc.
  - (c) attacks teeth and nails of humans
78. Cadmium is
- (a) beneficial for our health
  - (b) responsible for “itai itai” disease
  - (c) without effect on plants
79. Chlorinated organics (pesticides)
- (a) eradicated malaria
  - (b) are carcinogenic
  - (c) harmful for crops
80. The heavy metal, mercury is
- (a) useful, in traces, in medical treatment

- (b) a killer in its methyl form and responsible for Minamata diseases
- (c) useless for industries
81. Phosphatic fertiliser factories generate by product wastes
- (a) ammonium sulphate
- (b) phosphogypsum
- (c) potassium sulphate
82. Thermal power plants produce solid wastes
- (a) sulphur dioxide
- (b) calcium phosphate
- (c) fly ash
83. Pesticides are used to
- (a) favour growth of insects
- (b) reduce production of crops
- (c) kill pests and boost agricultural production
84. Pesticide residues
- (a) have no effect on environment
- (b) cause harm to birds, mammals and humans
- (c) are maximum among Indians
85. Integrated Pest Management (IPM) in agriculture means
- (a) control of pest population
- (b) eradication of pests
- (c) co-ordination of methods supplementing the effects of natural control agents
86. Arsenic (III) exerts toxic action by
- (a) attacking  $-OH$  (hydroxyl group) of an enzyme

- (b) attacking  $-SH$  (sulphydril group) of an enzyme
- (c) reaction with  $-NH_2$  (amino group) of protein
87. "itai itai" disease was caused by
- (a) zinc
- (b) cadmium
- (c) mercury
88. Minamata disease in Japan was due to
- (a) alkyl form of mercury
- (b) cadmium sulphate
- (c) lead chromate
89. Mercury pollution can be prevented by
- (a) banning use of mercury in any form in industries
- (b) banning all instruments using mercury such as thermometer, barometer, etc.
- (c) restricting use of mercurial pesticides and mercury electrodes in industries
90. Noise pollution occurs at
- (a) 20 decibels
- (b) above 90 decibels
- (c) above 150 decibels
91. Solid waste management is best conducted by
- (a) incineration
- (b) dumping into the seas
- (c) sanitary landfill
92. Love Canal dumpsite
- (a) did not harm the school and local residents

- (b) compelled the authorities to close the school and evacuate the residents in the area
- (c) favoured the growth of vegetation in the area
93. The ideal forest cover in relation to total land area is
- (a) 55%
- (b) 33%
- (c) 80%
94. Biosphere reserves have been declared by the Government for conservation of
- (a) water bodies
- (b) air
- (c) the different ecosystems
95. Environment Protection Act of 1986 is meant for
- (a) waste management
- (b) protection of human environment including humans, plants, animals and property
- (c) forest management
96. Chipko movement was launched for
- (a) stopping deforestation of hill forests in U.P.
- (b) land protection
- (c) wild life management
97. Silent Valley Movement succeeded in
- (a) waste management in the sea coast
- (b) cancelling the State Government hydel project and saving the Silent Valley
- (c) promoting marine fishery business in Kerala

98. Continental drifting is
- (a) due to motion of landmass
  - (b) due to earthquakes
  - (c) due to formation of mountains
99. Earthquakes are caused by
- (a) violent storms
  - (b) collision of tectonic plates
  - (c) volcanic explosion
100. Minamata disease occurred
- (a) as a result of oil pollution
  - (b) as a result of zinc discharge
  - (c) due to mercury poisoning
101. Bhopal disaster was possible
- (a) due to methyl isocyanate leakage
  - (b) due to steam discharge
  - (c) due to negligence of factory authorities
102. Chernobyl disaster happened
- (a) because of nuclear reactor explosion
  - (b) due to fly ash emission
  - (c) due to power plant failure
103. Big Bang was a cosmic event
- (a) some 1 billion years ago
  - (b) some 2 billion years ago
  - (c) some 6.5 billion years ago
104. Biome is
- (a) large land community with uniform plant species
  - (b) marine ecosystem
  - (c) tropical forest

105. Wetland ecosystem is
- (a) combined land and aquatic ecosystem
  - (b) ponds and lakes
  - (c) tropical forest
106. Urbanisation means
- (a) transformation of villages
  - (b) construction of cities with infrastructure
  - (c) migration of landless people
107. Lithosphere means
- (a) earth's interior core
  - (b) earth's crust
  - (c) underground water layer
108. Geologic cycle denotes
- (a) recycling of earth's crust
  - (b) weathering of soil
  - (c) eruption of volcanic lava
109. Biogeochemical cycles are
- (a) same as hydrological cycle
  - (b) similar to geological cycle
  - (c) circulation of chemical elements among biological organism and physical environment
110. Tornadoes are
- (a) storms and rains
  - (b) violent thunderstorms
  - (c) thunder, lightning and rain
111. Mangroves are
- (a) desert plants
  - (b) high altitude plants
  - (c) forests in tidal zones of equatorial and tropical coasts

112. Sustainable ecosystem consists of
- (a) land, forest and water ecosystem which can be renewed
  - (b) tropical forests
  - (c) coastal lakes and forests
113. Carrying capacity means
- (a) ability to carry the burden of goods
  - (b) maximum population that can be sustained by an ecosystem
  - (c) capacity to hold an ecosystem
114. Population density is
- (a) population size of a country
  - (b) number of people per sq. km. of an area
  - (c) population growth per year
115. Watershed is defined as
- (a) a water course
  - (b) drainage basin of a water course of a river or stream enclosed by hills
  - (c) waterfalls
116. Greenhouse gases are
- (a) carbon monoxide and sulphur dioxide
  - (b) carbon dioxide, methane, ozone
  - (c) chloroform, ether
117. El Nino is
- (a) atmospheric phenomenon
  - (b) volcanic activity
  - (c) ocean warming phenomenon
118. Odour pollution arises from
- (a) garbage heap, sewage water, etc.

(b) flowery plants

(c) public urinals and toilets

119. Hydroelectricity is generated from

(a) lakes and ponds

(b) water reservoir of river dam

(c) coal plants





---

# Question Papers

## Calcutta University (2003) Science Streams

*The figures in the margin indicate full marks*

1. Answer **any twelve** questions of the following giving (✓)  
mark in appropriate box: 2 × 12

1.1 Non-living components of ecosystem are

- (a) Biotic
- (b) Abiotic
- (c) Free living
- (d) None

1.2 Acid rain is caused by oxides of

- (a) SO<sub>2</sub>
- (b) NO<sub>2</sub>
- (c) Both

1.3 Converting solid waste into new products by  
using resources contained in the discarded  
material is

- (a) Waste management
- (b) Reuse
- (c) Recycling

- 1.4 Which amongst the following is decomposer in ecosystem?
- (a) Green plant
  - (b) Animal
  - (c) Bacteria
  - (d) (a) and (b)
- 1.5 Acidity in rain is measured by
- (a) Barometer
  - (b) Hygrometer
  - (c) Ammeter
  - (d) pH meter
- 1.6 The process by which anaerobic decomposition of organic matter by bacteria gives out a bad smell is
- (a) Decomposition
  - (b) Fermentation
  - (c) Putrefaction
- 1.7 Profuse growth of aquatic vegetation that often changes the colour of water and reduces the dissolved oxygen content is called
- (a) Algal bloom
  - (b) Eutrophication
  - (c) Fermentation
  - (d) (a) and (b)
- 1.8 Montreal Protocol signed in September 1987 aims at the control of
- (a) Use of ozone depleting substances
  - (b) Use of greenhouse gases
  - (c) Use of chemical pesticides
- 1.9 Stone cancer or stone leprosy is caused by
- (a) UV rays

- (b) Greenhouse effect
- (c) Acid rain
- (d) Ozone depletion
- 1.10 Tree hugging movement is
  - (a) Chipko Andolon
  - (b) Green movement
  - (c) Silent Valley movement
- 1.11 Rio declaration refers to
  - (a) Earth Summit in June 1992
  - (b) Ramsar conference
  - (c) Stockholm conference 1972
- 1.12 World Environment Day is observed on
  - (a) April 22
  - (b) June 22
  - (c) June 5
- 1.13 Ozone layer depletion occurs in
  - (a) Stratosphere
  - (b) Troposphere
  - (c) Ionosphere
- 1.14 Global warming is caused by
  - (a) Acid rain
  - (b) Ozone depletion
  - (c) Greenhouse gases
- 1.15 The source of oxygen in atmosphere is due to
  - (a) Respiration
  - (b) Excretion
  - (c) Photosynthesis
- 1.16 The scale that measures the magnitude of earthquake is
  - (a) Kelvin scale

- (b) Fahrenheit scale
- (c) Richter scale
- 1.17 At the time of formation of earth free oxygen in atmosphere was
- (a) Available
- (b) Non available
- 1.18 CFC is
- (a) Chlorofluorocarbon
- (b) Centre for Fuel control
- (c) Carcinogenic fluoride compound
- 1.19 Which amongst the following is primary consumer?
- (a) Bacteria
- (b) Tiger
- (c) Goat
- (d) Vulture
- 1.20 Of the following, water borne disease is
- (a) Small pox
- (b) Cholera
- (c) Diabetes
2. Answer **only ten** questions (within 2–3 lines)  $2 \times 10$
- 2.1 Define atmosphere.
- 2.2 What are the renewable and non-renewable energy sources? Give one example for each.
- 2.3 Name the principal gases of atmosphere.
- 2.4 State the importance of mangrove forest.
- 2.5 Define a producer (in ecology) giving an example.
- 2.6 What is wild life sanctuary?
- 2.7 Describe two major air pollutants emitted by automobiles.

- 2.8 What is BOD?
  - 2.9 What is biomass?
  - 2.10 What is wetland? Name two important wetlands in India.
  - 2.11 Name three sources of odour pollution.
  - 2.12 What is the permissible noise level at night as prescribed by the Central Pollution Control Board in (i) residential areas and (ii) in silent zones?
  - 2.13 Define biogeochemical cycle.
  - 2.14 State the impact of land degradation on agriculture.
  - 2.15 What is carrying capacity of environment?
  - 2.16 What is Green Bench?
  - 2.17 What is Agenda 21?
  - 2.18 Explain what is biomagnification.
  - 2.19 Explain what is composting.
  - 2.20 Name two Project Tiger Reserves in West Bengal.
3. Answer any *one* question (with in 120 words) 6 × 1
- 3.1 Explain what is biodiversity and the necessity for its preservation.
  - 3.2 Name two non-conventional energy sources and mention their possible applications in Indian context.
  - 3.3 Give an outline of natural and man made disaster.
  - 3.4 What are the measures to be taken to prevent water pollution-related diseases?
  - 3.5 What is nitrogen cycle? State the role of bacteria in nitrogen cycle.
  - 3.6 State the importance of wetland.

**Calcutta University (2003)**  
**Arts and Commerce Streams**

*The figures in the margin indicate full marks*

**1. Answer only twelve** questions putting (✓) marks in appropriate box: 2× 12

- 1.1 The earliest traces of life on earth have been found in the rocks of
- (a) 3.5 trillion years old
  - (b) 3.5 billion years old
  - (c) 3.5 million years old
- 1.2 Richter scale is used for measuring
- (a) Velocity of light
  - (b) Intensity of sound
  - (c) Amplitude of seismic waves
- 1.3 Bhopal gas disaster occurred in
- (a) 1964
  - (b) 1974
  - (c) 1984
- 1.4 In 1986 nuclear plant disaster took place in
- (a) London
  - (b) Chernobyl
  - (c) Three miles
- 1.5 First UN conference on Environment was held in
- (a) Johensburg
  - (b) Stockholm
  - (c) Montreal
- 1.6 Which one of the following gases is most abundant in atmosphere?
- (a) Methane

- (b) Nitrogen
- (c) CFC
- 1.7 The interiormost layer of the earth is known as
- (a) Core
- (b) Crust
- (c) Mantle
- 1.8 The landmass of the earth is known as
- (a) Biosphere
- (b) Lithosphere
- (c) Stratosphere
- 1.9 Mangroves are found in
- (a) Puskar lake
- (b) Sundarbans
- (c) Loktak lake
- 1.10 Which one of the following is a pollution-free renewable resource?
- (a) Fossil fuel
- (b) Solar energy
- (c) Wood
- 1.11 What is the name of the supercontinent which broke into the present day continents?
- (a) Pampas
- (b) Palaeartic
- (c) Pangaea
- 1.12 Ozone hole is present in
- (a) Biosphere
- (b) Troposphere
- (c) Stratosphere
- 1.13 Which one of the following is an autotroph?
- (a) Green plant

- (b) Fungus
- (c) Fish
- 1.14 Human malaria is transmitted by
- (a) *Anopheles* male
- (b) *Anopheles* female
- (c) *Culex* male
- 1.15 The safe intensity level of sound is
- (a) 85 decibel
- (b) 75 decibel
- (c) 65 decibel
- 1.16 The Silent valley is in
- (a) Andhra Pradesh
- (b) Himachal Pradesh
- (c) Kerala
- 1.17 Which one of the following is not a gaseous cycle?
- (a) Oxygen cycle
- (b) Phosphorous cycle
- (c) Nitrogen cycle
- 1.18 Which one of the countries is known as the land of monsoon?
- (a) Russia
- (b) India
- (c) Australia
- 1.19 The earth receives major energy from:
- (a) Sun
- (b) Moon
- (c) Mars



1.20 Which one of the following does not contain biomass?

(a) Municipal garbage

(b) Sewage

(c) Metal

2. Answer **only ten** questions (within 2–3 lines):  $2 \times 10$

2.1 What is meant by environmental studies?

2.2 What is succession?

2.3 Define wetland.

2.4 State the function of decomposers in an ecosystem.

2.5 What is biomagnification?

2.6 What is ecosystem?

2.7 Mention the major causes of air pollution in the urban areas.

2.8 What is biogas?

2.9 Define sustainable development.

2.10 State the importance of ozone layer.

2.11 What is Green Bench?

2.12 State the role of bacteria in nitrogen cycle.

2.13 What is meant by non conventional energy?

2.14 What is exponential growth of population?

2.15 What is fly ash?

2.16 Define carrying capacity

2.17 What is aquifer?

2.18 Define aerosol.

2.19 What is EIA?

2.20 What is geothermal energy?

3. Answer **any one** question (with in 120 words)  $6 \times 1$

3.1 Briefly mention the role of biotic components of an ecosystem.

3.2 State the ecological and economical importance of biodiversity.

- 3.3 Briefly explain hydrological cycle.
- 3.4 State how population growth and natural resources are related.
- 3.5 Explain Gaia hypothesis.
- 3.6 Give an outline of environmental ethics.

**Calcutta University (2004)**  
**Arts and Commerce Streams**

*The figures in the margin indicate full marks*

**1. Answer any twelve** questions of the following giving (✓)  
marks in appropriate box: 2× 12

- 1.1 Seismograph is used for the measurement of
- (a) Earthquake
  - (b) Intensity of light
  - (c) Humidity
- 1.2 Jaldapara is famous for the conservation of
- (a) Tiger
  - (b) Rhinoceros
  - (c) Elephant
- 1.3 Earth Day is celebrated on
- (a) 5th June
  - (b) 12th May
  - (c) 22nd April
- 1.4 The mean temperature of Earth is approximately
- (a) 10°C
  - (b) 15°C
  - (c) 20°C
- 1.5 Cholera is a
- (a) Vectorborne disease
  - (b) Waterborne disease
  - (c) Airborne disease
- 1.6 India is a megadiversity country with
- (a) 4 Ecological hotspots
  - (b) 3 Ecological hotspots
  - (c) 2 Ecological hotspots

- 1.7 The permissible upper limit of Arsenic in water is
- (a) 0.05 mg per litre
  - (b) 0.005 mg per litre
  - (c) 0.5 mg per litre
- 1.8 An ecological thinking in which no particular importance is given to man
- (a) Social Ecology
  - (b) Human Ecology
  - (c) Deep Ecology
- 1.9 The novel 'Aronnyok' is written by
- (a) Rabindra Nath Tagore
  - (b) Bibhutibhusan Bandopadhyay
  - (c) Jibanananda Das
- 1.10 The historic Earth Summit held at Rio, Brazil in June 1992 known as
- (a) UNCED
  - (b) UNIDO
  - (c) UNESCO
- 1.11 Ramsar Convention includes one of the following
- (a) Rabindra Sarovar
  - (b) Subhas Sarovar
  - (c) East Kolkata Wetland
- 1.12 The lowest layer of atmosphere
- (a) Ionosphere
  - (b) Troposphere
  - (c) Stratosphere
- 1.13 Bhopal gas disaster caused by the gas
- (a) Carbon monoxide
  - (b) Chlorofluro carbon
  - (c) Methyl isocyanate

- 1.14 'Arabari Model' in West Bengal is famous for
- (a) Joint Forest Management
  - (b) Rainwater Harvesting
  - (c) Solar Power Plant
- 1.15 The global human population is around
- (a) 480 crores
  - (b) 620 crores
  - (c) 760 crores
- 1.16 The name of Sundarlal Bahuguna is related to
- (a) Chipko Movement
  - (b) Narmada Bachao
  - (c) Silent valley
- 1.17 The famous 3P formula on environment is
- (a) Power-Production-Price
  - (b) Population-Poverty-Pollution
  - (c) Principle of Population Problem
- 1.18 On earth the autotropic components can directly fix
- (a) Chemical energy
  - (b) Mechanical energy
  - (c) Light energy
- 1.19 The unit of dose of ionising radiation is
- (a) ROM
  - (b) RAD
  - (c) CAD
- 1.20 B.O.D. determines the health of
- (a) Soil
  - (b) Air
  - (c) Water

2. Answer **any ten** questions (with 2–3 lines):  $2 \times 10$

- 2.1 State two causes of landslide.
- 2.2 Name two nitrogen fixing bacteria.
- 2.3 What is an inverted pyramid?
- 2.4 What is wasteland?
- 2.5 What is social forestry?
- 2.6 What is carrying capacity?
- 2.7 What is photochemical smog?
- 2.8 What is Decibel?
- 2.9 What is ozonehole?
- 2.10 What is urbanisation?
- 2.11 What is Chipko movement?
- 2.12 What is bioremediation?
- 2.13 What is environmental ethics?
- 2.14 What is bio-diesel?
- 2.15 What is El-Nino?
- 2.16 What is plate tectonics?
- 2.17 What is quarantine?
- 2.18 What is biodiversity?
- 2.19 What is a cyclone?
- 2.20 What is acid rain?

3. Answer **any one** question (within 120 words)  $6 \times 1$

- 3.1 Briefly state the air pollution status of Kolkata city.
- 3.2 Describe the importance of land use planning.
- 3.3 Briefly state your view about the river linking proposals in Indian context.
- 3.4 State the reasons of wildlife extinction.
- 3.5 State the impact of economic development on environment in India.
- 3.6 Discuss your view about the importance of water conservation in our country.

**Calcutta University (2004)**  
**Science Streams**

*The figures in the margin indicate full marks*

**1. Answer any twelve** questions of the following giving (✓)  
marks in appropriate box: 2× 12

1.1 Rachel Carson is the writer of the following book

- (a) Biodiversity
- (b) Silent Spring
- (c) Silent Valley

1.2 5th June is observed as:

- (a) Earth Day
- (b) Environment Day
- (c) Biodiversity Day

1.3 A chronic disease called 'Silicosis' involves:

- (a) Heart
- (b) Lung
- (c) Liver

1.4 A Bengali novel of forestry and environment is

- (a) 'Rupashi Bangla'
- (b) 'Sabhyatar Sankat'
- (c) 'Aronnyok'

1.5 Pollen can cause

- (a) Typhoid
- (b) Malaria
- (c) Allergy

1.6 Free floating microscopic organisms are known as

- (a) Nekton
- (b) Plankton
- (c) Periphyton

- 1.7 What happened in India in 1984?
- (a) Chipko movement
  - (b) Bhopal gas disaster
  - (c) Narmada Bachao Andolon.
- 1.8 Lithosphere represents the earth's
- (a) Water
  - (b) Land
  - (c) Life
- 1.9 Chernobyl nuclear power disaster took place in
- (a) 1984
  - (b) 1986
  - (c) 1988
- 1.10 *Plasmodium vivax* can cause
- (a) Filaria
  - (b) Malaria
  - (c) Dengu
- 1.11 The name of Rabindra Nath Tagore is connected with
- (a) Joint Forest Management
  - (b) Vanamahatsava
  - (c) Tree hugging movement
- 1.12 The physical space occupied by an organism is known as
- (a) Niche
  - (b) Habitat
  - (c) Ecotone
- 1.13 Earthquake is measured by
- (a) Electro encephalograph
  - (b) Seismograph
  - (c) Barometer



- 1.14 'Study of habitat' is known as
- (a) Ecology
  - (b) Entomology
  - (c) Ethology
- 1.15 Aggregation of organisms of different populations refers to
- (a) Density
  - (b) Diversity
  - (c) Population
- 1.16 Following is a primary consumer
- (a) Green plant
  - (b) Deer
  - (c) Tiger
- 1.17 Biological control refers to
- (a) Control of an organism by another organism
  - (b) Control of an organism by using pesticide
  - (c) Control of organism by themselves
- 1.18 Earth is a
- (a) Planet
  - (b) Galaxy
  - (c) Star
- 1.19 'Agenda-21' refers to
- (a) 1972 Stockholm Summit
  - (b) 1992 Rio-Summit
  - (c) 2002 Johannesburg Summit
- 1.20 Following is not found in natural condition in India
- (a) Tiger
  - (b) Zebra
  - (c) Rhinoceros

- 
2. Answer **any ten** questions (within 2–3 lines):  $2 \times 10$
- 2.1 What is a Biome?
  - 2.2 What is Green belt?
  - 2.3 What is Minamata disease?
  - 2.4 What is Sanctuary?
  - 2.5 What is Biofertilizer?
  - 2.6 What is Metropolis?
  - 2.7 What is IUCN?
  - 2.8 What is Biological warfare?
  - 2.9 What is organic farming?
  - 2.10 What is Environmentalism?
  - 2.11 What is endangered species?
  - 2.12 What is Dam?
  - 2.13 What is waste?
  - 2.14 What is afforestation?
  - 2.15 What is soil-erosion?
  - 2.16 What is Euro II (Bharat Stage II) in auto emission?
  - 2.17 What is an 'Ecocity'?
  - 2.18 What is E.I.A.?
  - 2.19 Name four common waterbirds.
  - 2.20 Name four common water pollutants.
3. Answer **any one** question (within 120 words)  $6 \times 1$
- 3.1 Briefly state the environmental consciousness of Indian people.
  - 3.2 Make comments on the implementation of environmental laws in India.
  - 3.3 Briefly discuss the different components of a forest ecosystem.
  - 3.4 What are the direct and indirect uses of Biodiversity.
  - 3.5 Discuss the different alternative sources of energy.
  - 3.6 Briefly state the importance of water conservation in our country.

# APPENDIX 1



---

## The Time Scale of Evolution

---

<i>Time</i>	<i>Event</i>
6.5–7.00 billion years ago	The Big Bang
4.50 billion years ago	The Earth was born
3.50 billion years ago	The blue-green algae (plant) was formed
3.00 billion years ago	The animal appeared
0.0025–0.0030 billion (23–30 lakh) years ago	The man appeared

---



---

# The International SI Units

The modern textbooks have adopted the System International (SI) Units. However, these have not yet been accepted in toto. In this book some SI units, universally adopted, have been used while the more familiar units, e.g.  $A^\circ$ , atm, degree Celsius, etc. are retained.

<i>Physical quantity</i>	<i>Name of Unit</i>	<i>Symbol</i>
Length	metre	m
Mass	kilogram	kg
Amount of substance	mole	mol
Energy	Joule	J
Temperature	Kelvin ( $1^\circ\text{C} = \text{K}-273$ )	K

---

1 Calorie (thermochemical) = 4.184 J



## Drinking Water Quality Standards

In this Table the permissible limits for water quality parameters, as laid down by the United States Public Health Standard (USPH) for drinking water and Indian Standards Institution (ISI), are listed for comparison. The ISI values, available for only a few parameters, are found to be much higher than those for USPH for no valid reasons. All the units, except for pH and E. Coli, are in ppm or mg/ml.

<i>Parameters</i>	<i>USPH Standard</i>	<i>ISI Standard</i>
PH	6.0–8.5	6.0–9.0
Dissolved Oxygen (D.O.)	4.0–6.0 (ppm)	3.0
Chemical Oxygen Demand (COD)	4.0	—
Total dissolved solids	500	—
Suspended solid	5.0	—
Chloride	250	600
Sulphate	250	1000
Cyanide	0.05	—
Nitrate + Nitrite	< 10	—
Fluoride	1.5	3.0
Phosphate	0.1	—

(Contd)

---

<i>Parameters</i>	<i>USPH Standard</i>	<i>ISI Standard</i>
Ammonia	0.5	—
Total hardness (as CaCO <sub>3</sub> )	500	—
Calcium	100	—
Magnesium	30	—
Arsenic	0.05	0.2
Cadmium	0.01	—
Chromium (VI)	0.05	0.05
Iron (filtrable)	< 0.3	—
Lead	0.05	0.01
Mercury	0.001	—
Zinc	5.5	—
Phenols	0.001	0.005
E. Coli (Coliform cells)/1000 ml (Bacteriological parameter)	100	—

---



---

# Toxic Chemicals in the Environment

There are a number of chemicals in the environment. Some of them are toxic while the rest are non-toxic. The toxic chemicals are discharged by industries into air, water and soil. They enter our biological system through food chain and disturb the metabolic processes, leading in some cases to fatal results.

At present there are four million known chemicals in the world and we are adding to the list, 30,000 new compounds every year. Among these 60,000–70,000 chemicals are commonly used. Apart from their benefit to increasing production, living standards and health, many of them are potentially toxic.

## Toxic Chemicals in Air

- Acrylonitrile, Arsenic, Asbestos
- Benzene, Beryllium
- Cadmium, Chromium, Chlorinated Solvents, Coke oven emissions, Chlorofluorocarbons
- Ethylene Dibromide, Ethylene Oxide
- Lead, Mercury
- Ozone

- Polycyclic Aromatic Hydrocarbons
- Sulphur Dioxide

### **Toxic Chemicals in Water**

#### Trace Elements

- Arsenic
- Beryllium, Boron
- Cadmium, Chromium, Copper
- Fluoride
- Lead
- Manganese, Mercury, Molybdenum
- Selenium
- Zinc
- Pesticides (from agricultural run-off)





---

## The Haves and Have-nots (Developed and Developing Countries)

**80 : 20 Ratio** 20 per cent of the world population (developed countries) consume 80 per cent of the world's resources (natural), generate 75 per cent of total solid wastes and are responsible for 70 per cent of global environmental damage.

USA, with about half of India's population and double of India's area, discharges 5000 million tons of carbon dioxide every year—five times more than India.

Al Gore, ex-Vice President of USA—UNEP magazine vol. 6, No. 2, 1994—The North (developed countries) accounts for over consumption of resources while the south (developing countries), for population explosion and poverty.



---

## One Earth, One Family (Global Village)

The UNEP (United Nations Environment Programme) theme for 1994 was One Earth, One Family:

The Earth is not merely a “hotel”—it is our “home”.

It is a place, where we should not use the resources and then move to another spot for further exploration.

—it is a place that we should cherish and need to protect.

It is not merely a “resource” or “retreat”, which we use, enjoy and then leave.

—it is our **Mother**.

# APPENDIX 7



---

## India's Rank in the World

<i>Parameter</i>	<i>Rank</i>
Population	2 (next to China)
Area	7
Value added in Agriculture	5
Electricity generation	8
Value added in manufacturing	14
Gross Domestic Product	15
Export of Goods and Services	30
Human Development Index	128



---

## References

1. A.K. De—*Environmental Chemistry*, 5th edition, New Age International (P) Ltd. New Delhi (2003).
2. A.K. De—*Environmental Studies*, Rural Technology Centre, University of Burdwan (1999), Chapters 1–4.
3. T.M. Das—*Man, an Endangered Species*, Shaibya Prakasan, Calcutta (1995).
4. T.M. Das—*Is the Earth for Man Only?* Jonaki Publishers, Calcutta, 4th edition, (1995).
5. T.M. Khosoo—*Environmental Priorities in India and Sustainable Development*, Indian Science Congress Association, New Delhi (1986).
6. D.D. Monte—*Temples or Tombs?* Centre for Science and Environment, New Delhi (1985).
7. A.K. Agarwal (Editor)—*The State of India's Environment*, (1984–85), Centre for Science and Environment, New Delhi (1985).
8. A.K. Mitra—*Urban Environment in Crisis*, New Age International (P) Ltd., New Delhi (2000).
9. G.D. Friedman—*Primer of Epidemiology*, 3rd ed., McGraw-Hill, New York (1988).

**This page  
intentionally left  
blank**



---

# Index

- Acid rain 102  
Activated sludge 75  
Algal bloom 71  
Amoebiasis 157  
Anthropogenic 4  
Arsenic contamination 73  
Asbestosis 147  
Atmosphere 18, 21, 86  
Autotrophic 38
- Bhopal disaster 219  
Big bang 16  
Biodiversity 45  
Biogas 136  
Biomes 39  
Biosphere 22, 184  
Biotechnology 163, 179  
Byssinosis 148
- Carbon cycle 30  
Carcinogens 167  
Catalytic converters 97
- Chernobyl disaster 9  
Chlorofluorocarbons 92  
Chipko movement 188  
Composting 177  
Continental drift 5
- Decibel 111  
Dependency ratio 52  
Desalination 80  
Doubling time 52
- Earth summit 46  
Ecology 370  
Ecosystems 40  
Effluent 75, 78  
El Nino 94  
Encephalitis 151  
Energy plantation 139  
Environment 1  
Environmental degradation 2  
Environmental Impact  
Assessment (EIA) 188

- Environmental refugees 57  
Environmental studies 2  
Epidemiology 148  
Eutrophication 71
- Fertility rate 52  
Fungicides 159  
Fuel 125
- Ganga Action Plan 79  
Ganga pollution 73  
Geologic cycle 26  
Geothermal energy 139  
Global warming 89  
Grazing land 65  
Green bench court 187  
Greenhouse effect 89  
Greenhouse gases 91  
Ground water pollution 73  
Gulf war hazards 10  
Hazardous products 143  
Herbicides 159  
Heterotrophic 38  
Human development 57  
Human development index (HDI) 57  
Hydel project 129  
Hydroelectricity 128  
Hydrological cycle 26  
Hydrosphere 21  
Hygiene 149
- Incineration 178  
Industrial revolution 7, 127  
Infant mortality 53
- Inorganic pollutants 72  
Insecticides 159  
Itai-itai disease 165
- Kelvin 88  
Kerala model 55
- Land use 3, 62  
Life expectancy 53  
Lithosphere 19  
London smog 8
- Mangroves 41  
Mediterranean 8  
Mesosphere 87  
Meteorology 108  
Minamata disease 9, 166  
Montreal protocol 93
- Natural gas 133  
Nitrogen cycle 29  
Noise pollution 110  
Nuclear explosion 8  
Nuclear power 130
- Occupational hazards 146  
Ocean energy 138  
Odour pollution 117  
Organic pollutants 70  
Oxygen cycle 28  
Ozone hole 92
- Particulate matter 104  
Peroxy acyl nitrate (PAN) 100  
Pesticide 159

- 
- Photochemical smog 99  
Phosphate cycle 31  
Pneumoconiosis 148  
Population crash (explosion) 54  
Population density 54  
Population stabilisation 54  
Primary pollutants 95
- Rain harvesting 78  
Recycling 78  
Renewable energy resource 133
- Sanctuaries 44, 186  
Sanitary landfill 176  
Sediment 70  
Semi-conductors 136  
Sink 89, 97  
Silent valley movement 189  
Silicosis 147  
Sludge 78
- Soil 20  
Solar energy 133  
Soot 105  
Specide 46  
Stockholm conference 11  
Stratosphere 87  
Sulphur cycle 33  
Sulphur dioxide 100
- Vector-borne diseases 151
- Water pollution 69  
Water quality 77  
Water recycling 78  
Water resources 68  
Watershed 64  
Wasteland 66  
Waste treatment 172  
Waste water treatment 75  
Wind energy 137  
Woman power 37